

## ALLP1

### Applications

The ALLP1 is a cost-effective area light designed to offer optimal flexibility to the customer. The ALLP1 provides multiple combinations of options to maximize labor and energy savings. The ALLP1 Area Light provides uniform distribution for area and site lighting in retail, commercial, and residential applications including driveways and parking areas.

Project Name:	
Catalog Number:	
Type:	
Note:	
Date:	



ALLP1B1UNVFD8CSBRT43CRSP



IP65



FIELD ADJUSTABLE  
WATTAGE/LIGHT  
OUTPUT AND CCT



### Construction & Design

- Type II, III, IV, and Type V light distributions
- Field selectable lumens provide a late point adjustment at the installation site
- 12,000 to 42,000 lumens
- Nine lumen packages
- Precision engineered lens made of optical grade polycarbonate for maximum light intensity
- Anti-corrosion stainless steel hardware
- Heavy duty die-cast aluminum housing with external heat-sink for optimal thermal management
- Fixture comes standard in bronze
- Field selectable CCT between 3000K, 4000K or 5000K
- Minimum 80 CRI
- Efficacy up to 158 LPW

### Additional Options

- Lens field install kits for each light distribution type (Type II, III, IV, V)
- Multiple mounting options
- Light shield kit options

### Electrical

- Available in 120v-277v and 277v-480v
  - 10kV/5kA Surge Protection Standard
  - Power Factor >0.90\*
  - Total Harmonic Distortion < 20%\*
- \*Note: Varies based on option

### Control and Sensor Options

- Factory installed NEMA 3-pin photocell receptacle comes standard (shorting cap included)
- Photo control and occupancy sensor options available
- Fixture comes sensor ready for field installed Motion sensor options

### Lumen Maintenance

See lumen maintenance table on page 2

### Fixture Certifications & Listings

- UL/cUL Wet Locations
- IK08 Impact Rating
- IP65 Rated
- 3.0G Vibration load rating per ANSI C136.31
- DarkSky Compliant. 3000K must be selected with direct pole mount to meet International DarkSky Association approval criteria
- DesignLights Consortium™ Premium qualified luminaire
- Visit the [DLC QPL](#) for listed models

### Warranty

See Orion's [Product Limited Warranty](#) for more details and information

### Performance Information, 277v, ≥80 CRI, 5000K<sup>1</sup>

Lumen Code	Lumens Nominal	Type II				Type III				Type IV				Type V			
		Wattage	Actual Lumens	LPW	BUG	Wattage	Actual Lumens	LPW	BUG	Wattage	Actual Lumens	LPW	BUG	Wattage	Actual Lumens	LPW	BUG
A1	12,000	81w	12,054lm	149	B3-U0-G3	80w	11,973lm	150	B3-U0-G2	80w	11,946lm	149	B3-U0-G3	80w	11,582lm	145	B4-U0-G2
	14,000	100w	14,348lm	144	B3-U0-G3	99w	14,251lm	144	B3-U0-G2	99w	14,219lm	144	B3-U0-G3	99w	13,786lm	140	B4-U0-G2
B1	15,000	105w	15,542lm	148	B3-U0-G3	105w	15,267lm	146	B3-U0-G3	106w	15,058lm	142	B3-U0-G3	105w	15,051lm	144	B4-U0-G2
	20,000	146w	20,166lm	138	B3-U0-G3	145w	19,809lm	136	B3-U0-G3	147w	19,538lm	133	B3-U0-G3	145w	19,529lm	135	B4-U0-G2
C1	24,000	168w	23,250lm	138	B4-U0-G4	173w	23,177lm	134	B4-U0-G3	169w	23,339lm	138	B4-U0-G3	171w	22,946lm	135	B5-U0-G3
	28,000	201w	27,229lm	135	B4-U0-G4	207w	27,142lm	131	B4-U0-G3	201w	27,333lm	136	B4-U0-G3	204w	26,873lm	132	B5-U0-G3
D1	32,000	238w	33,337lm	140	B4-U0-G3	237w	33,291lm	140	B4-U0-G3	234w	33,239lm	142	B4-U0-G4	235w	33,257lm	141	B5-U0-G4
	36,000	268w	37,028lm	138	B4-U0-G3	268w	36,977lm	138	B4-U0-G3	263w	36,919lm	140	B4-U0-G4	265w	36,939lm	139	B5-U0-G4
	42,000	304w	40,990lm	135	B4-U0-G3	304w	40,933lm	135	B4-U0-G3	299w	40,869lm	137	B4-U0-G4	301w	40,892lm	136	B5-U0-G4

### Lumen Maintenance<sup>2</sup>

Lumen Code	Nominal Lumens	Operating Temperature	Calculated Lumen Maintenance		
			L70	L80	L90
A1	12,000 / 14,000	25°C	189,000	119,000	57,000
		50°C	153,000	94,000	46,000
B1	15,000 / 20,000	25°C	184,000	116,000	55,000
		50°C	150,000	94,000	45,000
C1	24,000 / 28,000	25°C	162,000	102,000	49,000
		50°C	154,000	97,000	46,000
D1	32,000 / 36,000 / 42,000	25°C	173,000	108,000	52,000
		50°C	140,000	86,000	41,000

### Additional Specification Information

<sup>1</sup> Actual performance may vary by up to ±10% of values listed; facility factors and fixture options can affect performance values.

<sup>2</sup> Calculated hours based on TM-21 projections and components used at the time of testing. Warranty is not associated with Calculated Lumen Maintenance

### Physical Information<sup>3</sup>

Nominal Lumen Code	Length	Height	Width	Weight	EPA [side] Using Slipfitter
A1/B1/C1	15.63"	2.38"	11.18"	9.00 lbs.	.64 ft <sup>2</sup>
D1	19.65"	2.38"	13.97"	12.20lbs.	.77 ft <sup>2</sup>

**A1/B1/C1**

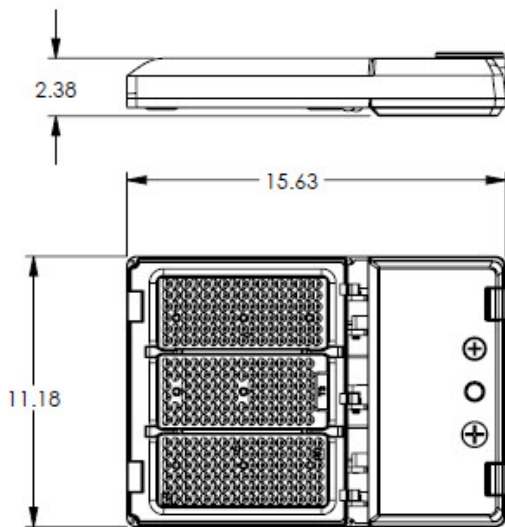

**D1**

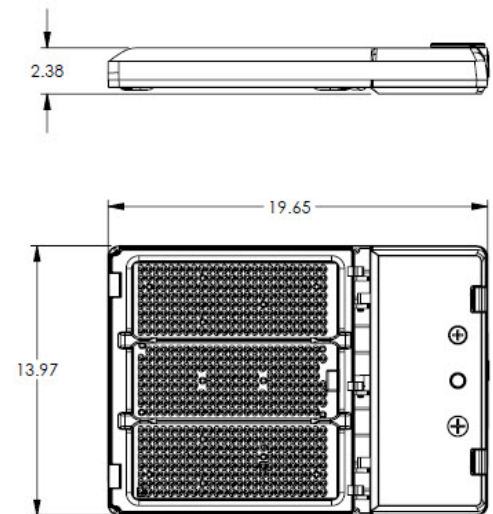

### Ambient Operating Temperatures

Nominal Lumen Code	Standard Range
All Lumen Packages	-40°C to 50°C [-40°F to 122°F]

Sensor Type	Operating Range
All Sensors	-30°C to 50°C [-22°F to 122°F]

### Additional Specification Information

<sup>3</sup> Weight will vary based on option selection

Ordering Information Example (NOTE: No dashes or spaces unless noted below)

**ALLP1B1UNVFD8CST43CRSP**

### Ordering Information

Series	Nominal Lumen Code <sup>4</sup>	Voltage	Driver Type	CRI; Color Temp	Fixture Colors	Light Distribution	Standard Factory Installed	Packaging Options
<b>ALLP1=</b> HARRIS LED Lumen Select Area Light, Gen 1	<b>A1=</b> Lumen Selectable 12,000 lm/ 14,000 lm <b>B1=</b> Lumen Selectable 15,000 lm/ 20,000 lm <b>C1=</b> Lumen Selectable 24,000 lm/ 28,000 lm <b>D1=</b> Lumen Selectable 32,000 lm/ 36,000 lm/ 42,000lm	<b>UNV=</b> 120v-277v <b>HMV=</b> 277v-480v	<b>FD=</b> Full Dimming	<b>8CS=</b> 80CRI; Color Selectable 3000K / 4000K / 5000K	<b>BR=</b> Bronze	<b>T2=</b> Type II <b>T3=</b> Type III <b>T4=</b> Type IV <b>T5=</b> Type V	<b>3CR=</b> 3-Pin Universal NEMA Receptacle and Sensor Ready** <sup>5</sup>	<b>SP=</b> Single Pack
<p><b>*Note:</b> All fixtures are set to max lumen range output at 5000K at the factory EX: ALLPIA1=14,000 at 5000K]      <b>**Note:</b> See Page 5 for Photocell and Motion Sensor Options</p>								

### Fixture Options (Factory Installed)



3-Pin NEMA Receptacle (includes shorting cap)



Motion Sensor Ready

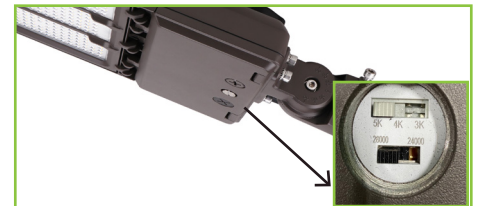

Field Selectable Lumens and CCT

### Additional Specification Information

<sup>4</sup> For actual lumens, see performance table

<sup>5</sup> Use of Sensor and Photocell together is not recommended

### Accessories [Sold Separately-Field Installed]

Mounting Options	
EXT-ALLP-SFT-001	Bronze Slip-fitter, 2-3/8" Tenons
EXT-ALLP-TRN-001	Bronze Trunnion Mount
EXT-ALLP-ADJ-001	Bronze Adjustable Pole Mount, 3" Round Pole, Max 5" Round, Min. 3" Square Pole
EXT-ALLP-WM-001	Bronze Adjustable Wall Mount Arm Kit
EXT-ALLP-DPM-001	Bronze Direct Pole Mount, Dark Sky Compliant, 3" Round Pole, Max 5" Round, Min. 3" Square Pole
Light Shield Options	
EXT-ALLP-FLS-001	Bronze Back and Side Light Shields, A1/B1/C1
EXT-ALLP-FLL-001	Bronze Back and Side Light Shields, D1
Control Options <sup>5</sup>	
EXT-ALLP-PE3-001	Twist-lock Photocell On/Off Daylight Sensing Only, 120v-277v
EXT-ALLP-PE3-002	Twist-lock Photocell On/Off Daylight Sensing Only, 347v
EXT-ALLP-PE3-003	Twist-lock Photocell On/Off Daylight Sensing Only, 480v
Motion Sensor Options <sup>5,6</sup>	
<a href="#">EXT-LSW-RC</a>	Remote Control for Sensor Commissioning [For HB02DPR and HB01DMS-A Sensors]
<a href="#">HB02DPR</a>	PIR Occupancy/Daylight Sensor, High and Low End Trim, 0-10v Dimming, 20' max. mounting height
<a href="#">HB01DMS-A</a>	Microwave Occupancy Sensor, Photosensor, Low End Trim, 0-10v Dimming, IR Remote Programmable, 45' max. mounting height
Lens Kit Options - Field Replacement	
ROL-ALLP1-S-T2	Replacement Lens: ALLP, Light distribution Type II [T2], Small [A1/B1/C1]
ROL-ALLP1-S-T3	Replacement Lens: ALLP, Light distribution Type III [T3], Small [A1/B1/C1]
ROL-ALLP1-S-T4	Replacement Lens: ALLP, Light distribution Type IV [T4], Small [A1/B1/C1]
ROL-ALLP1-S-T5	Replacement Lens: ALLP, Light distribution Type V [T5], Small [A1/B1/C1]
ROL-ALLP1-L-T2	Replacement Lens: ALLP, Light distribution Type II [T2], Large [D1]
ROL-ALLP1-L-T3	Replacement Lens: ALLP, Light distribution Type III [T3], Large [D1]
ROL-ALLP1-L-T4	Replacement Lens: ALLP, Light distribution Type IV [T4], Large [D1]
ROL-ALLP1-L-T5	Replacement Lens: ALLP, Light distribution Type V [T5], Large [D1]

### Accessories [Field Installed]



Slipfitter  
[EXT-ALLP-SFT-001]



Trunnion Mount  
[EXT-ALLP-TRN-001]



Adjustable Arm Mount  
[EXT-ALLP-ADJ-001]

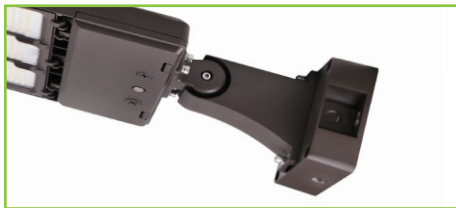

Adjustable Wall Arm Mount  
[EXT-ALLP-WM-001]



Direct Pole Mount  
[EXT-ALLP-DPM-001]



Light Shield  
[EXT-ALLP-FLx-001]

### Additional Specification Information

<sup>5</sup> Use of Sensor and Photocell together is not recommended

<sup>6</sup> Sensor options are only approved for use when using the max lumen switch position. Power usage and dimming levels are only accurate when using max lumen switch position

Accessories [Field Installed]



Photocell  
[EXT-ALLP-PE3-00x]

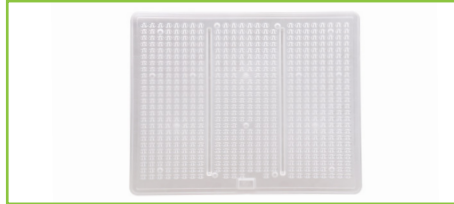

Lens Kit  
[ROL-ALLP1-x-Tx]

ISO Footcandle Plots

Visit [orionlighting.com](http://orionlighting.com) to obtain all .IES files

B1 850 T2

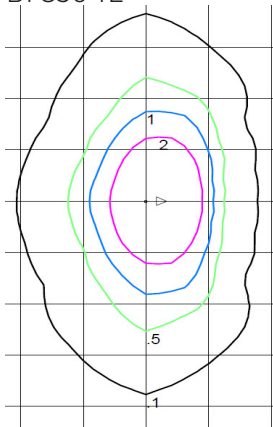

Distance are in Units of Mounting Height  
Mounting Height 30'  
Max. Calculated Value: 6.58 Fc

B1 850 T3

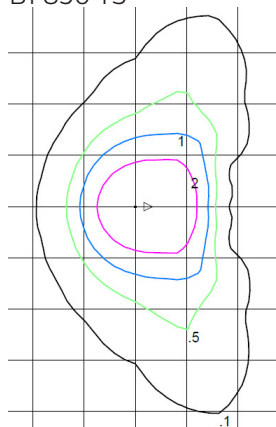

Distance are in Units of Mounting Height  
Mounting Height 30'  
Max. Calculated Value: 4.92 Fc

B1 850 T4

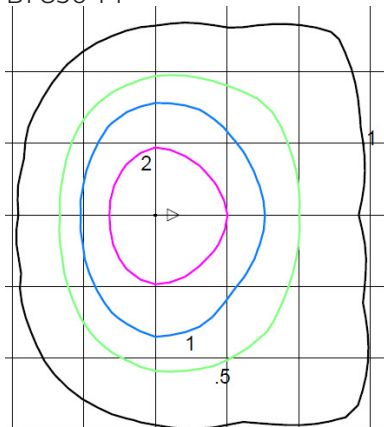

Distance are in Units of Mounting Height  
Mounting Height 30'  
Max. Calculated Value: 3.82 Fc

B1 850 T5

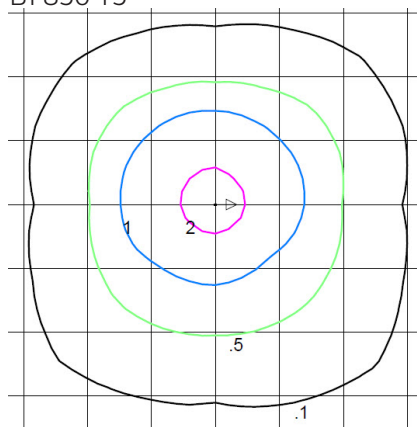

Distance are in Units of Mounting Height  
Mounting Height 30'  
Max. Calculated Value: 2.48 Fc

### Fixture with Mounting Dimensions and Physical Information

#### Slipfitter Mount (EXT-ALLP-SFT)

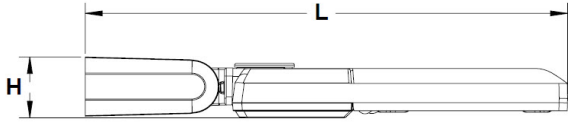

Lumen Code	Length	Height	Width	Weight	EPA [side @ 0°]
A1/B1/C1	22.51"	2.93"	11.18"	10.40lbs.	.64 ft <sup>2</sup>
D1	26.53"	2.93"	13.97"	13.60lbs.	.77 ft <sup>2</sup>

**Note:** This slipfitter can adapt to 2-3/8" tenons.

#### Trunnion Mount (EXT-ALLP-TRN)

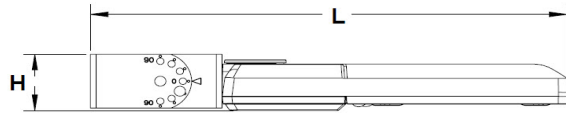

Lumen Code	Length	Height	Width	Weight	EPA [side @ 0°]
A1/B1/C1	21.60"	2.88"	11.18"	12.10lbs.	.63 ft <sup>2</sup>
D1	25.62"	2.88"	13.97"	13.97lbs.	.92 ft <sup>2</sup>

#### Adjustable Arm Mount (EXT-ALLP-ADJ)

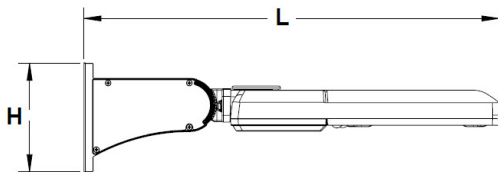

Lumen Code	Length	Height	Width	Weight	EPA [side @ 0°]
A1/B1/C1	24.15"	6.30"	11.18"	11.40lbs.	.80 ft <sup>2</sup>
D1	28.17"	6.30"	13.97"	14.60lbs.	.75 ft <sup>2</sup>

**Note:** This mounting kit can adapt to round poles [3">5" diameter and square poles [min. 3"]

#### Adjustable Wall Mount (EXT-ALLP-WM)

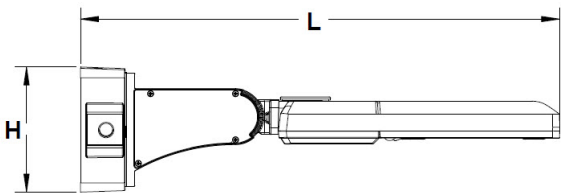

Lumen Code	Length	Height	Width	Weight	EPA [side @ 0°]
A1/B1/C1	26.63"	6.94"	11.18"	13.60lbs.	.89 ft <sup>2</sup>
D1	30.65"	6.94"	13.97"	16.80lbs.	1.01 ft <sup>2</sup>

#### Direct Pole Mount (EXT-ALLP-DPM)

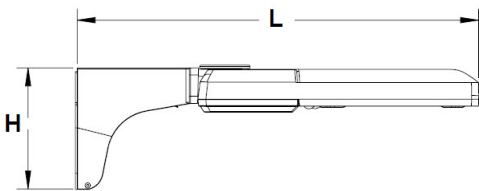

Lumen Code	Length	Height	Width	Weight	EPA [side @ 0°]
A1/B1/C1	23.70"	6.94"	11.18"	13.00lbs.	.75 ft <sup>2</sup>
D1	27.50"	6.94"	13.97"	16.20lbs.	.87 ft <sup>2</sup>

**Note:** This mounting kit can adapt to round poles [3">5" diameter and square poles [min. 3"]