

## Hi-lume 1% 2-Wire LED Driver Forward-Phase Control Overview

The Hi-lume 1% 2-Wire LED Driver is a high-performance LED driver that provides smooth, continuous 1% dimming for virtually any LED fixture, whether it requires constant-current or constant-voltage. It is the most versatile LED driver offered today due to its compatibility with a wide variety of LED arrays, multiple form factors, and numerous control options.

### Features

- Continuous, flicker-free dimming from 100% to 1%.<sup>1</sup>
- Guaranteed compatibility with selected Maestro Wireless, RadioRA 2, HomeWorks QS, GRAFIK Eye QS, GRAFIK Systems, Quantum, and C•L dimmers. Please see **Compatible Controls** chart or contact Lutron for details regarding compatible controls.
- QwikFig compatible. For more information please refer to Lutron P/N 041473 (K and M case only).
- 100% performance tested at factory.
- A rated lifetime of 50,000 hours @  $t_c=149^\circ\text{F}$  ( $65^\circ\text{C}$ ).
- UL recognized and listed options for United States and Canada.
- NOM certified option for Mexico.
- Type TL Rated.<sup>2</sup>
- FCC Part 15 compliant for commercial and residential (UL Listed only) applications at 120 V~.
- Pulse width modulation (PWM) or constant-current reduction (CCR) dimming methods available. See Application Note #360 for details.
- RoHS Compliant
- For more information please go to: [www.lutron.com/hilume1led](http://www.lutron.com/hilume1led)

<sup>1</sup> Light output at 1% depends on the efficacy of the light engine used with the driver.

<sup>2</sup> Type TL ratings are not offered for all output ranges. Consult detailed specifications on the following pages for availability.

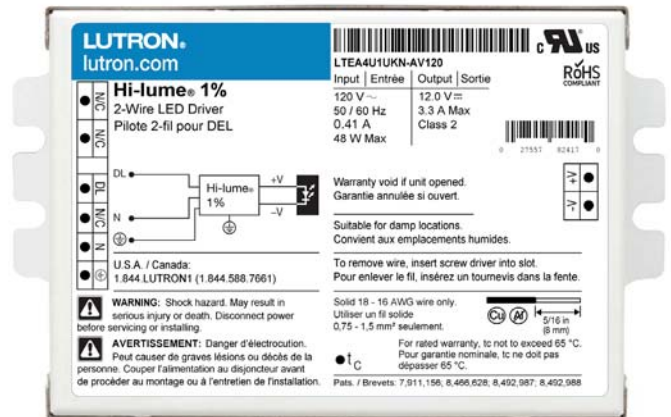

### Case type K

3.00 in (76 mm) W x 1.00 in (25 mm) H x  
4.90 in (124 mm) L



### Case type M

1.18 in (30 mm) W x 1.00 in (25 mm) H x  
14.25 in (362 mm) L



### Case type KL

K-case mounted on a 4.00 in (102 mm) W x  
1.50 in (38 mm) H x 4.00 in (102 mm) L junction  
box to provide wiring compartment

Job Name:

Model Numbers:

Job Number:

## Specifications

### Regulatory Approvals

- Meets ANSI C62.41 category A surge protection standards up to and including 4 kV.
- FCC Part 15 compliant for commercial and residential (UL Listed only) applications.
- Manufacturing facilities employ ESD reduction practices that comply with the requirements of ANSI/ESD S20.20.
- Lutron Quality Systems registered to ISO 9001.2008.
- UL 8750 recognized.
- UL recognized models are also UL classified to 1598C for field replacement capability.
- UL 8750 listed form factor available.
- Class 2 output available.
- Type TL Rated.<sup>1</sup>
- LTEA4U1NKL-AV120 and LTEA4U1NKL-CV240 models are NOM certified and available for Mexico.

### UL 8750 Listed Option

- cULus for United States and Canada available for certain operating regions.
- Pre-wired and installation ready.
- See **KL Case: Case Dimensions** page for more specific details regarding UL listed option.
- UL 8750 Listed construction.
- Integral junction box to save time.
- For maximum driver-to-LED light engine wire length, see **Driver Leads** section near the end of this document.

### Environmental

- Sound Rating: Inaudible in 27 dB ambient.
- Relative Humidity: Maximum 90% non-condensing.
- Minimum operating ambient temperature  $t_a = 32\text{ }^\circ\text{F}$  ( $0\text{ }^\circ\text{C}$ ).<sup>2</sup>

### Performance

- Dimming Range: 100% to 1%.
- Operating Voltage: 120 V ~ at 50/60 Hz
- Requires Forward Phase Control; please see **Compatible Controls** chart.
- A rated lifetime of 50,000 hours @  $t_c = 149\text{ }^\circ\text{F}$  ( $65\text{ }^\circ\text{C}$ ).
  - For rated warranty,  $t_c$  not to exceed the maximum rated temperatures.<sup>3</sup>
- Patented thermal foldback protection.
- LEDs turn on to any dimmed level without going to full brightness.
- Non-volatile memory restores all driver settings after power failure.
- Power Factor:  $>0.90$  at 40 W.
- Total Harmonic Distortion (THD):  $<20\%$  at 40 W.
- Inrush Current:  $<2\text{ A}$ .
- Inrush Current Limiting Circuitry: eliminates circuit breaker tripping, switch arcing and relay failure.
- Open circuit protected.
- Short circuit protected.
- Turn-on time:  $\leq 1.5$  seconds.<sup>4</sup>
- PWM Dimming Frequency: 550 Hz.

### Driver Wiring & Mounting

- Driver is grounded by a mounting screw to the grounded fixture (or by terminal connection on the K case).
- Terminal blocks on the driver accept one solid wire per terminal from 18 AWG to 16 AWG ( $0.75\text{ mm}^2$  to  $1.5\text{ mm}^2$ ).
- Fixture must be grounded in accordance with local and national electrical codes.
- For maximum driver-to-LED light engine wire length, see charts in **Driver Leads** section at the end of the document.

<sup>1</sup> Type TL ratings are not offered for all output ranges. Consult detailed specifications on the following pages for availability.

<sup>2</sup> Where  $t_a$  is the temperature of the air directly surrounding the driver.

<sup>3</sup> Installer is responsible for ensuring that the driver case temperature does not exceed the maximum rated temperature.

<sup>4</sup> Models available with turn-on time  $\leq 1$  second.

<b>Job Name:</b>  <b>Job Number:</b>	<b>Model Numbers:</b>
--	-----------------------

## How to Build a Model Number: Hi-lume 1% 2-Wire LED Driver

**LTEA4U1**

**Certification:**  
 U = UL/cULus Listed  
 N = NOM Certified

**Case Size:**  
 K = Compact  
 M = Stick

**Case Style:**  
 S = Studded (K case only)  
 N = Non-Studded  
 L = UL Listed (K case only)

**Example: LTEA4U1UKS-HC070**  
 For further assistance selecting your model number, contact our LED Center of Excellence at 1.877.346.5338 or LEDs@lutron.com

**Current Level (for Constant-Current):**  
 020 = 0.20 A; 021 = 0.21 A...070 = 0.70 A...210 = 2.10 A

**Voltage Level (for Constant-Voltage):**  
 100 = 10.0 V; 105 = 10.5 V...600 = 60.0 V

**Driver Output:**

C = Constant-current driver with pulse width modulation (PWM) dimming  
 A = Constant-current driver with constant-current reduction (CCR) dimming  
 V = Constant-voltage driver with pulse width modulation (PWM) dimming

**LED Load Output Range (see the following pages for more detail):**

<u>Class 2 Constant-Voltage</u>	<u>Class 2 Constant-Current</u>	<u>Isolated Non-Class 2 Constant-Current</u>
A = 10.0 V–12.0 V	E = 0.20 A–0.50 A 30 V–54 V	Y = 0.20 A–0.50 A 30 V–60 V
B = 12.5 V–20.0 V*	F = 0.51 A–1.00 A 30 V–54 V*	Z = 0.51 A–1.00 A 30 V–60 V*
C = 20.5 V–24.0 V*	G = 0.20 A–0.70 A 8 V–20 V	
D = 24.5 V–38.0 V*	H = 0.20 A–0.70 A 15 V–38 V	
	I = 0.71 A–1.05 A 8 V–20 V	
<u>Isolated Non-Class 2 Constant-Voltage</u>	J = 0.71 A–1.05 A 15 V–38 V	
X = 38.5 V–60.0 V*	K = 1.06 A–1.50 A 8 V–20 V	
	L = 1.06 A–1.50 A 15 V–38 V*	
	M = 1.51 A–2.10 A 8 V – 19.9 V*	

\* Output parameter is power-limited for these output ranges. Consult detailed specifications on the following pages for each range.

<b>Job Name:</b>	<b>Model Numbers:</b>
<b>Job Number:</b>	

# How to Build a Bulk Model Number (For use with Lutron QwikFig technology): Hi-lume 1% 2-Wire LED Driver

**LTEA4U1U - BLK**

**Case Size:**  
K = Compact  
M = Stick

**Case Style:<sup>1</sup>**  
S = Studded  
(K-case only)  
N = Non-Studded  
(All M-case models)

**Bulk Models:**  
Coverage based on “LED Load Output Range” from standard non-configurable models shown in the **How to Build a Model Number** section. Example Standard Model Number: LTEA4U1UKS-HC070 has LED load output range = H

K-case and M-case  
1A = Covers “LED Load Output Range” Y and Z  
2A = Covers “LED Load Output Range” M  
3A = Covers “LED Load Output Range” E and F (CCR dimming only)

K-case only  
2G = Covers “LED Load Output Range” G  
2H = Covers “LED Load Output Range” H  
2R = Covers “LED Load Output Range” I and K  
2S = Covers “LED Load Output Range” J and L

M-case only  
2B = Covers “LED Load Output Range” H, J, and L  
2C = Covers “LED Load Output Range” G, I, and K

**Note:** Only the model numbers falling into the structure listed above can be configured with QwikFig. Standard model numbers configured at Lutron will not be capable of being reconfigured at another facility.

<sup>1</sup> QwikFig bulk drivers are only available as UL recognized.

<b>Job Name:</b>	<b>Model Numbers:</b>
<b>Job Number:</b>	

### “A” Output Range, Voltage Driver Models

Driver Type	Output Dimming Method	Output Voltage	Output Current	Output Power	Standards Recognition	KL Case Option	Standards Recognition for KL Case
Constant-Voltage Driver (Class 2)	Pulse Width Modulation (PWM)	10.0–12.0 V PWM	0.42–3.3 A	5–40 W		Yes	

#### Voltage Driver Operation Range:

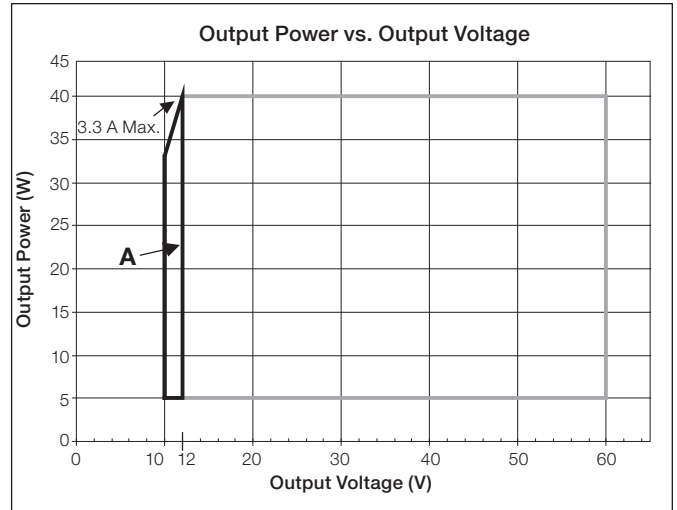
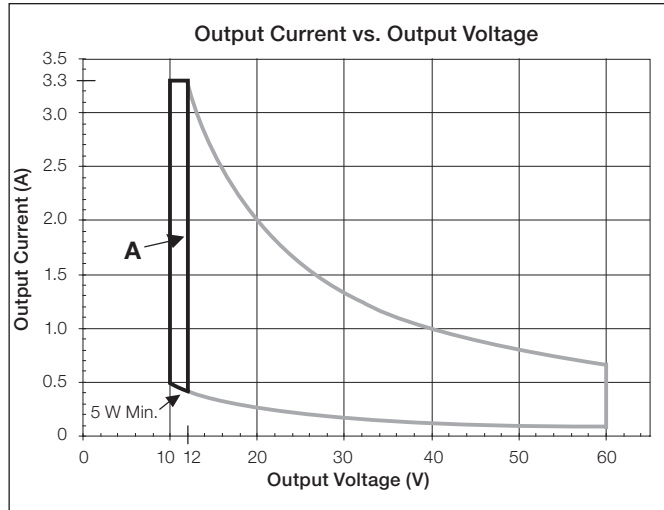

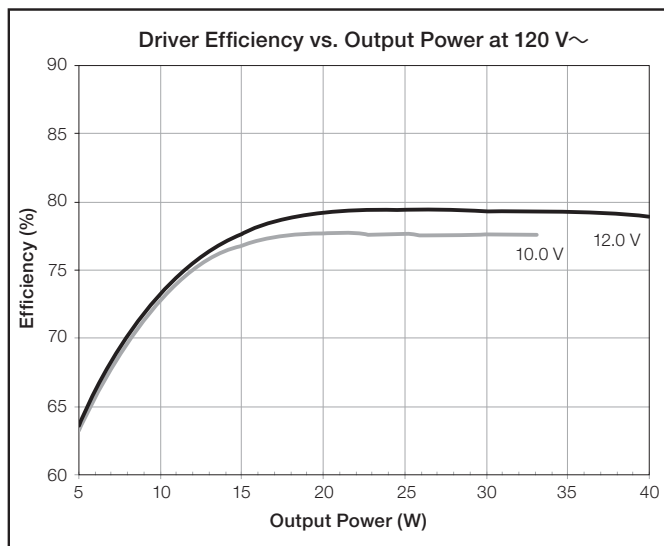

#### Typical Performance Specifications:

Parameter	Value	Test Conditions
Input Current	410 mA	$t_a = 25\text{ }^\circ\text{C}$ , 12.0 V 40 W load, Maximum Light Output, K case 120 V~ without a dimmer
Power Factor	0.98	
THD	16%	
Driver Efficiency	79%	



Job Name:	Model Numbers:
Job Number:	

## “B” Output Range, Voltage Driver Models

Driver Type	Output Dimming Method	Output Voltage	Output Current	Output Power	Standards Recognition	KL Case Option	Standards Recognition for KL Case
Constant-Voltage Driver (Class 2)	Pulse Width Modulation (PWM)	12.5–20.0 V PWM	0.25–3.2 A	5–40 W		Yes	

### Voltage Driver Operation Range:

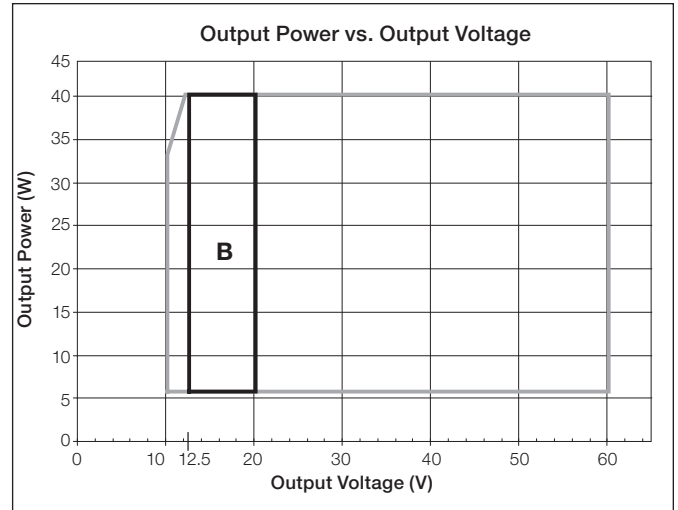
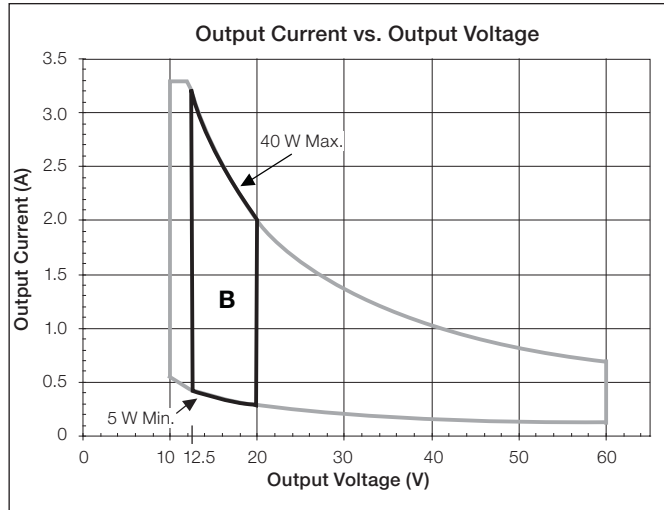

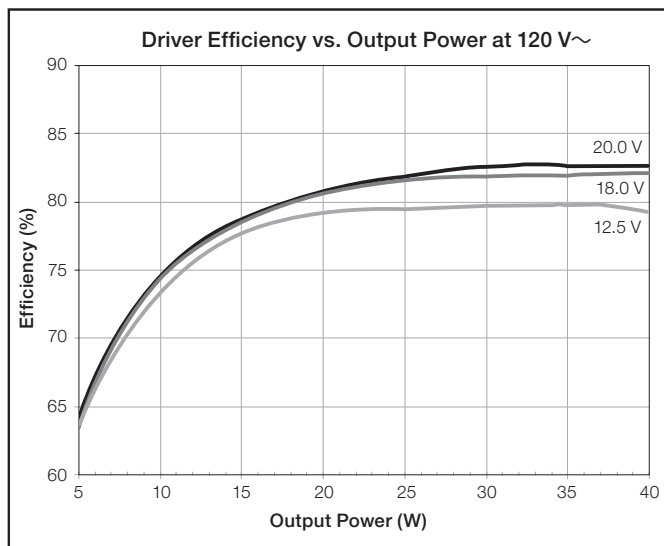

### Typical Performance Specifications:

Parameter	Value	Test Conditions
Input Current	400 mA	$t_a = 25\text{ }^\circ\text{C}$ , 20.0 V 40 W load, Max. Light Output, K case 120 V~ without a dimmer
Power Factor	0.99	
THD	9%	
Driver Efficiency	83%	



Job Name:	Model Numbers:
Job Number:	

### “C” Output Range, Voltage Driver Models

Driver Type	Output Dimming Method	Output Voltage	Output Current	Output Power	Standards Recognition	KL Case Option	Standards Recognition for KL Case
Constant-Voltage Driver (Class 2)	Pulse Width Modulation (PWM)	20.5–24.0 V PWM	0.21–1.95 A	5–40 W		Yes	

#### Voltage Driver Operation Range:

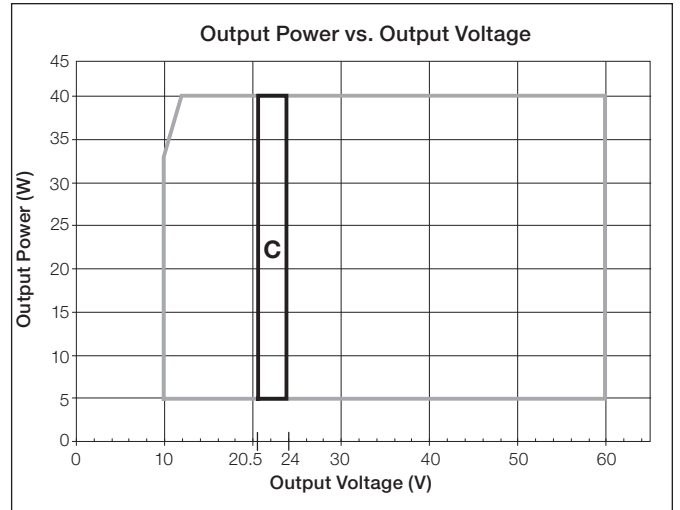
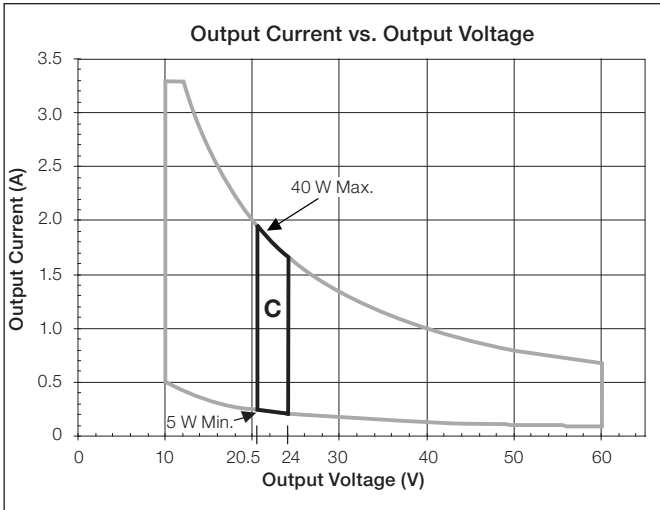

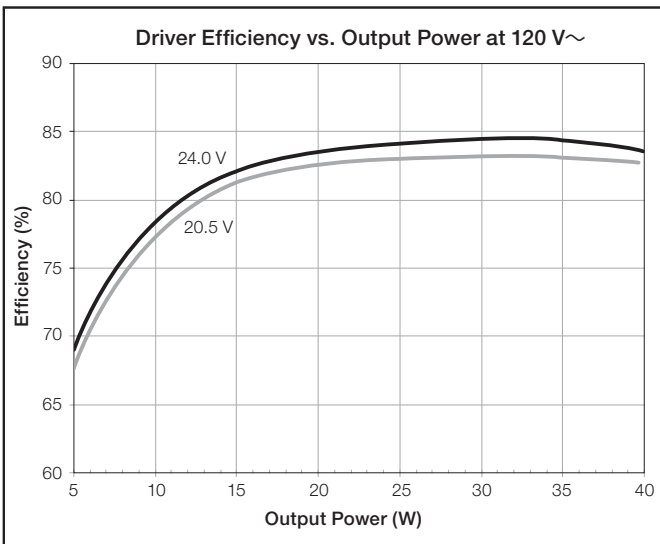

#### Typical Performance Specifications:

Parameter	Value	Test Conditions
Input Current	370 mA	$t_a = 25\text{ }^\circ\text{C}$ , 24.0 V 40 W load, Maximum Light Output, K case 120 V~ without a dimmer
Power Factor	0.99	
THD	10%	
Driver Efficiency	84%	



Job Name:	Model Numbers:
Job Number:	

## “D” Output Range, Voltage Driver Models

Driver Type	Output Dimming Method	Output Voltage	Output Current	Output Power	Standards Recognition	KL Case Option	Standards Recognition for KL Case
Constant-Voltage Driver (Class 2)	Pulse Width Modulation (PWM)	24.5–38.0 V PWM	0.13–1.63 A	5–40 W		Yes	

### Voltage Driver Operation Range:

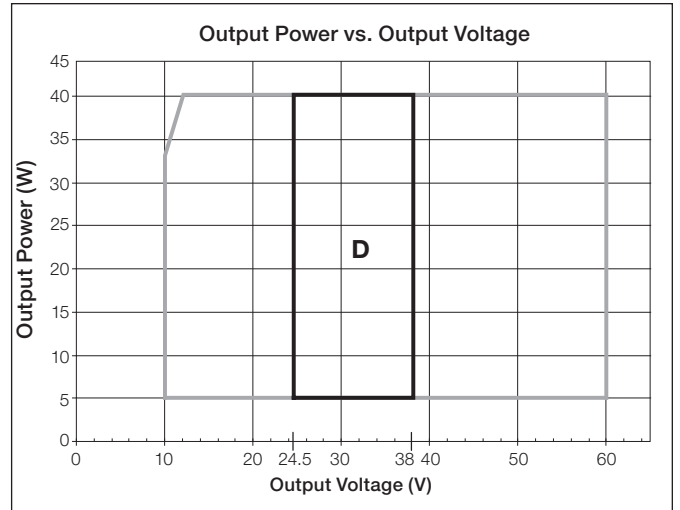
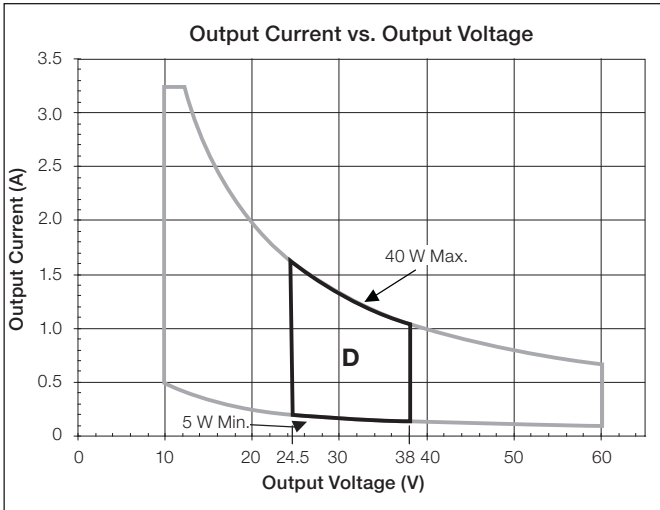

### Typical Performance Specifications:

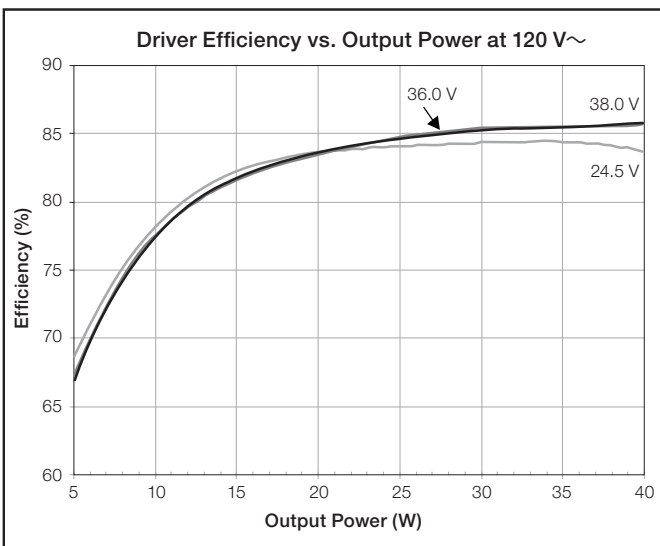

Parameter	Value	Test Conditions
Input Current	380 mA	$t_a = 25\text{ }^\circ\text{C}$ , 38.0 V 40 W load, Maximum Light Output, K case 120 V~ without a dimmer
Power Factor	0.99	
THD	7%	
Driver Efficiency	86%	



Job Name:	Model Numbers:
Job Number:	



### “E” Output Range, Current Driver Models

Driver Type	Output Dimming Method	Output Voltage	Output Current	Output Power	Standards Recognition	KL Case Option	Standards Recognition for KL Case
Constant-Current Driver (Class 2)	Constant-Current Reduction (CCR)	30–54 V $\sim$	0.20–0.50 A	6–27 W	 Type TL 82 °/74 °C - K-case Type TL 86 °/72 °C - M-case	Yes	

When using QwikFig technology, these models can be built from the following bulk units:

K-case - LTEA4U1UKx-3ABLK\*; M-case - LTEA4U1UMN-3ABLK

\* x = studded (S) or non-studded (N)

#### Current Driver Operation Range:

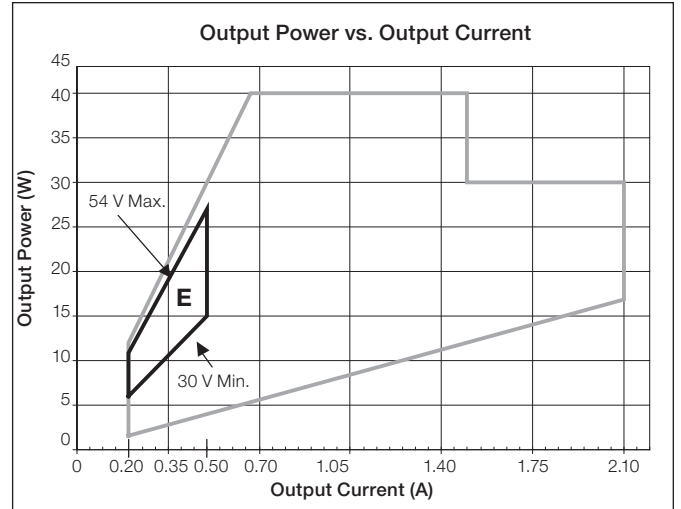
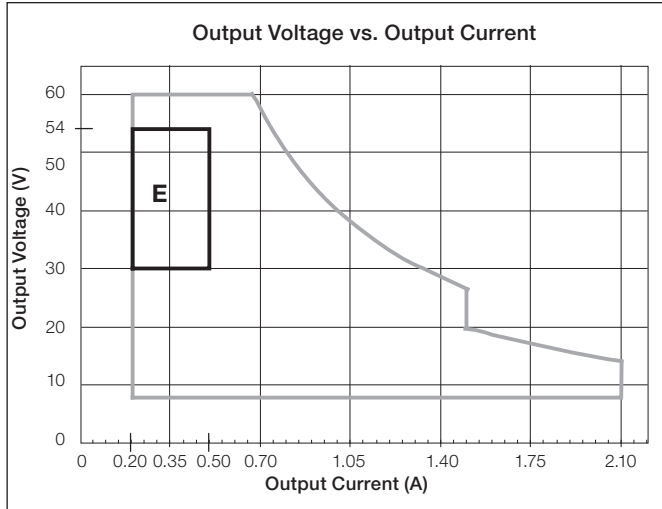

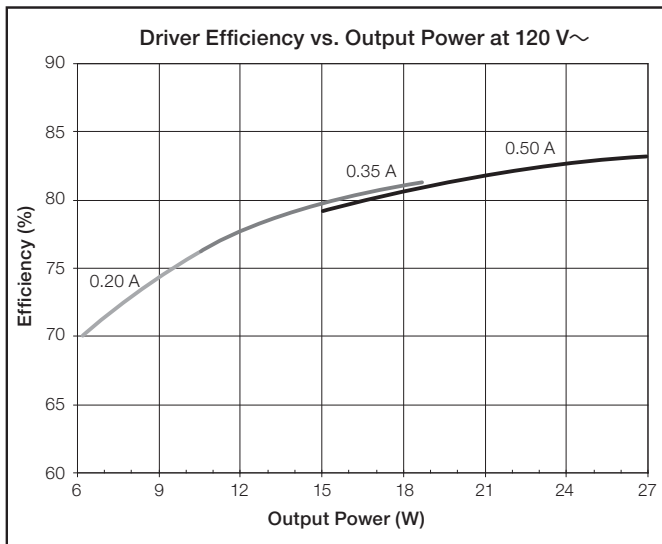

#### Typical Performance Specifications:

Parameter	Value	Test Conditions
Input Current	260 mA	$t_a = 25\text{ }^\circ\text{C}$ ,
Power Factor	0.99	0.50 A 27 W load,
THD	10%	Maximum Light Output,
Driver Efficiency	83%	K case 120 V $\sim$ without a dimmer



Job Name:	Model Numbers:
Job Number:	

### “F” Output Range, Current Driver Models

Driver Type	Output Dimming Method	Output Voltage	Output Current	Output Power	Standards Recognition	KL Case Option	Standards Recognition for KL Case
Constant-Current Driver (Class 2)	Constant-Current Reduction (CCR)	30–54 V $\approx$	0.51–1.00 A	15–40 W	 Type TL 82 °/74 °C - K-case Type TL 86 °/72 °C - M-case	Yes	

When using QwikFig technology, these models can be built from the following bulk units:

K-case - LTEA4U1UKx-3ABLK\*; M-case - LTEA4U1UMN-3ABLK

\* x = studded (S) or non-studded (N)

#### Current Driver Operation Range:

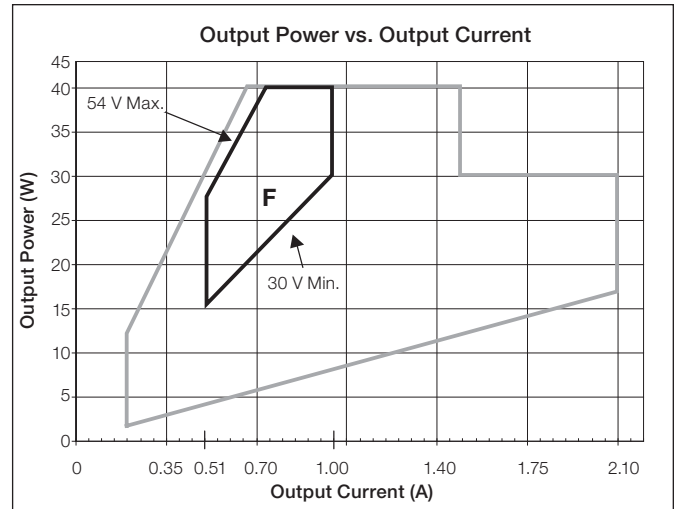
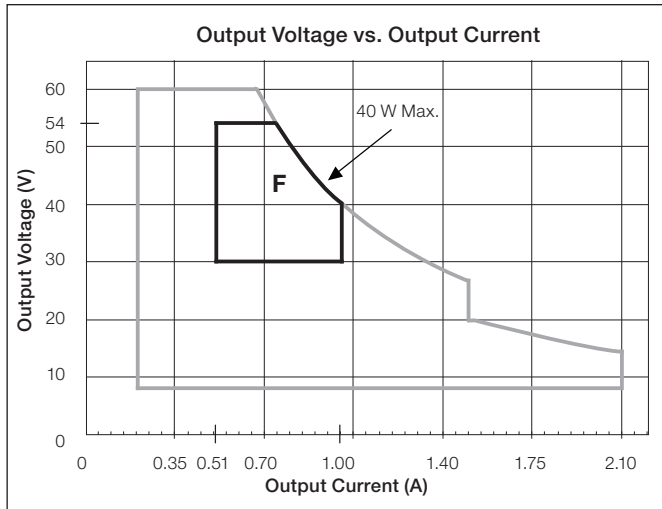

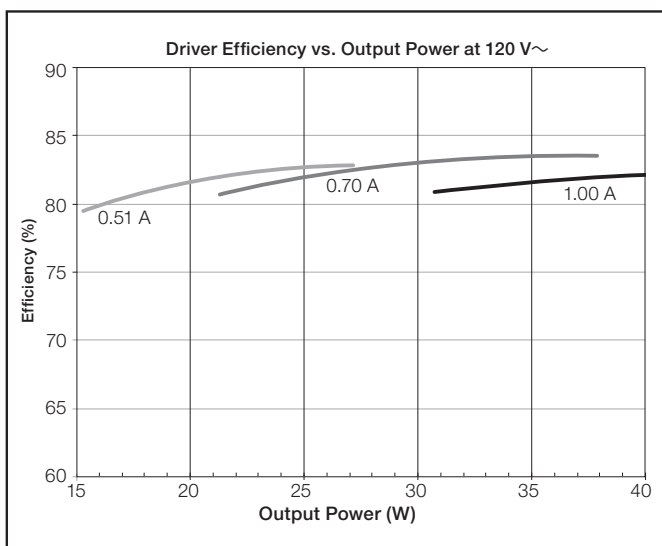

#### Typical Performance Specifications:

Parameter	Value	Test Conditions
Input Current	390 mA	$t_a = 25\text{ }^\circ\text{C}$ , 1.00 A 40 W load, Maximum Light Output, K case 120 V $\sim$ without a dimmer
Power Factor	0.99	
THD	7%	
Driver Efficiency	82%	



Job Name:	Model Numbers:
Job Number:	

### “G” Output Range, Current Driver Models

Driver Type	Output Dimming Method	Output Voltage	Output Current	Output Power	Standards Recognition	KL Case Option	Standards Recognition for KL Case
Constant-Current Driver (Class 2)	Pulse Width Modulation (PWM)	8–20 V PWM	0.20–0.70 A	2–14 W	 Type TL 86 °/57 °C - K-case Type TL 90 °/69 °C - M-case	Yes	
	Constant-Current Reduction (CCR)	8–20 V $\equiv$					

When using QwikFig technology, these models can be built from the following bulk units:

K-case - LTEA4U1UKx-2GBLK\*; M-case - LTEA4U1UMN-2CBLK

\* x = studded (S) or non-studded (N)

#### Current Driver Operation Range:

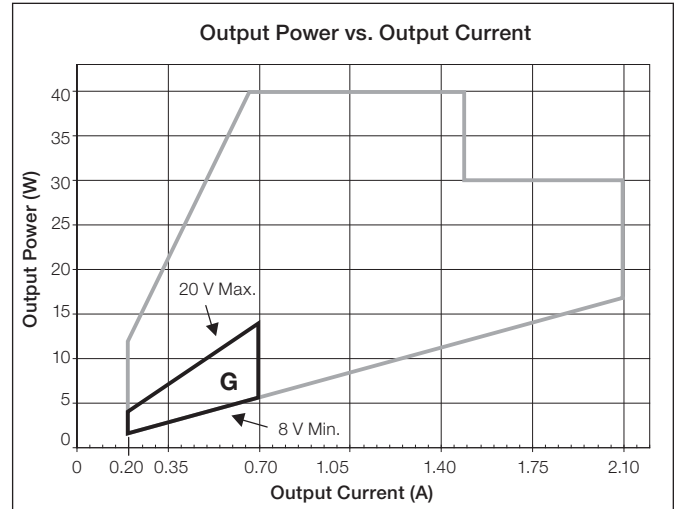
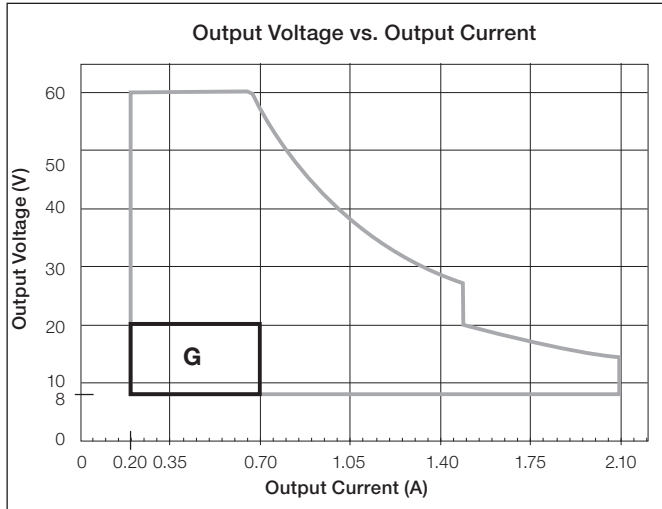

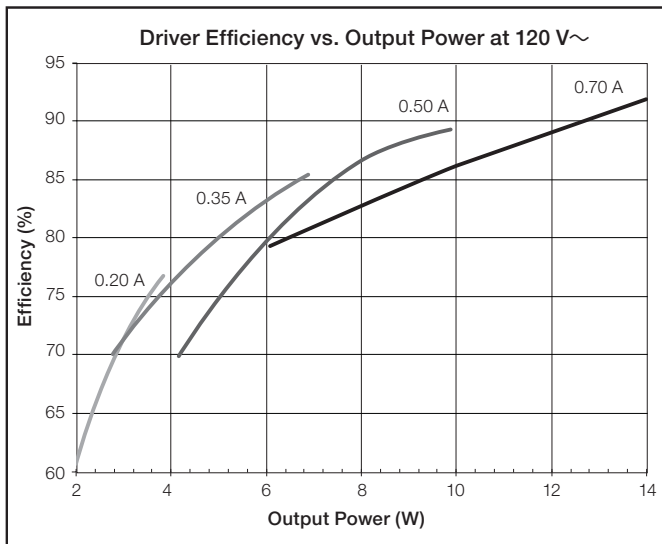

#### Typical Performance Specifications:

Parameter	Value	Test Conditions
Input Current	140 mA	$t_a = 25\text{ }^\circ\text{C}$ ,
Power Factor	0.99	0.70 A 14 W load,
THD	12%	Maximum Light Output,
Driver Efficiency	92%	K case 120 V $\sim$ without a dimmer



Job Name:	Model Numbers:
Job Number:	

### “H” Output Range, Current Driver Models

Driver Type	Output Dimming Method	Output Voltage	Output Current	Output Power	Standards Recognition	KL Case Option	Standards Recognition for KL Case
Constant-Current Driver (Class 2)	Pulse Width Modulation (PWM)	15–38 V PWM	0.20–0.70 A	3–26.6 W	 Type TL 84 °/62 °C - K-case Type TL 86 °/78 °C - M-case	Yes	
	Constant-Current Reduction (CCR)	15–38 V---					

When using QwikFig technology, these models can be built from the following bulk units:

K-case - LTEA4U1UKx-2HBLK\*; M-case - LTEA4U1UMN-2BBLK

\* x = studded (S) or non-studded (N)

#### Current Driver Operation Range:

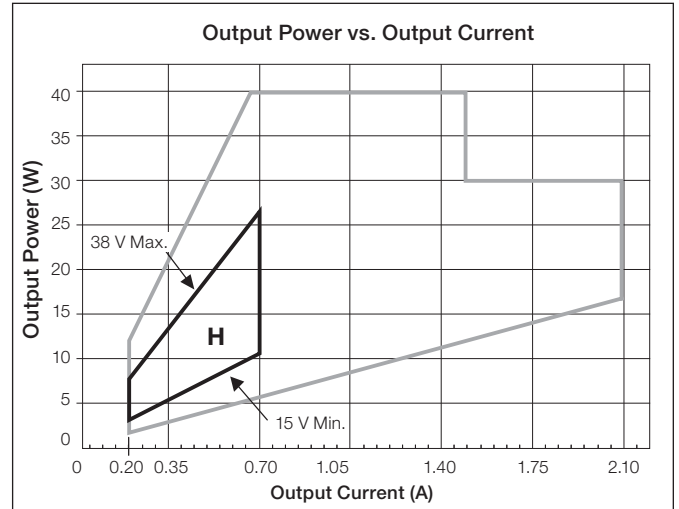
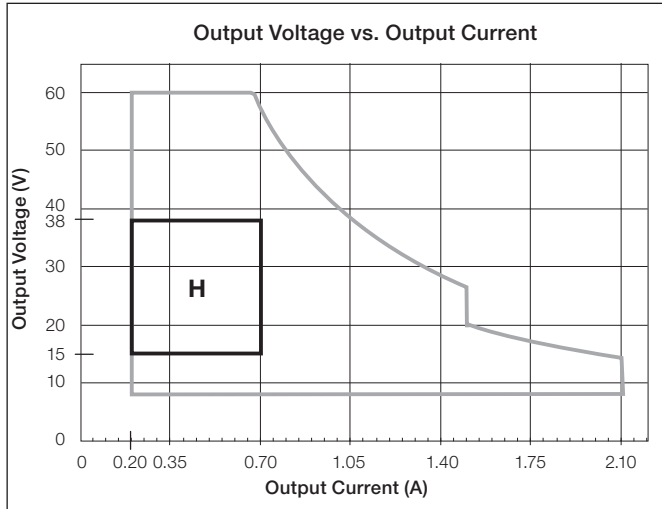

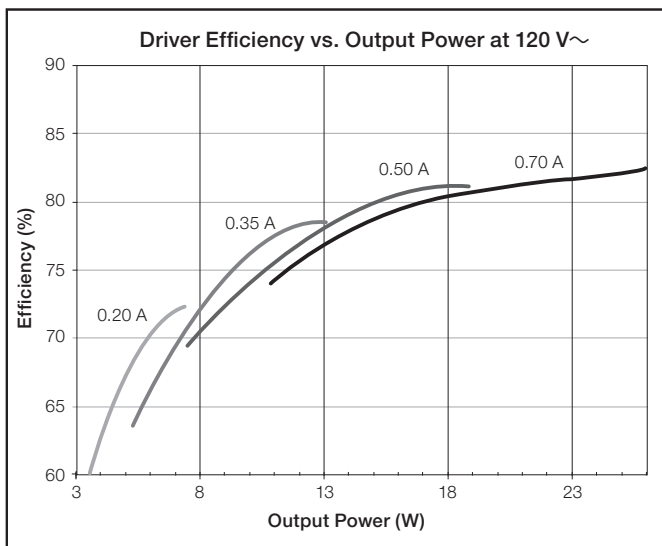

#### Typical Performance Specifications:

Parameter	Value	Test Conditions
Input Current	260 mA	$t_a = 25\text{ }^\circ\text{C}$ ,
Power Factor	0.99	0.70 A 26 W load,
THD	8%	Maximum Light Output,
Driver Efficiency	83%	K case 120 V~ without a dimmer



Job Name:	Model Numbers:
Job Number:	

### “I” Output Range, Current Driver Models

Driver Type	Output Dimming Method	Output Voltage	Output Current	Output Power	Standards Recognition	KL Case Option	Standards Recognition for KL Case
Constant-Current Driver (Class 2)	Pulse Width Modulation (PWM)	8–20 V PWM	0.71–1.05 A	6–21 W	 Type TL 80 °/74 °C - K-case Type TL 90 °/69 °C - M-case	Yes	
	Constant-Current Reduction (CCR)	8–20 V $\equiv$					

When using QwikFig technology, these models can be built from the following bulk units:

**K-case** - LTEA4U1UKx-2RBLK\*; **M-case** - LTEA4U1UMN-2CBLK

\* x = studded (S) or non-studded (N)

#### Current Driver Operation Range:

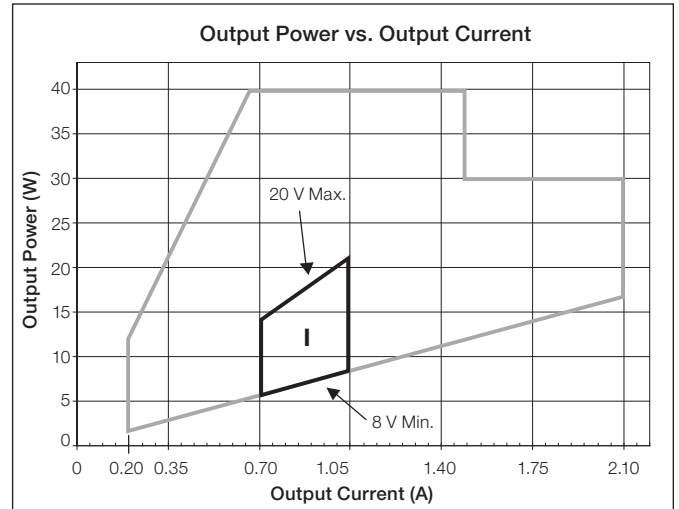
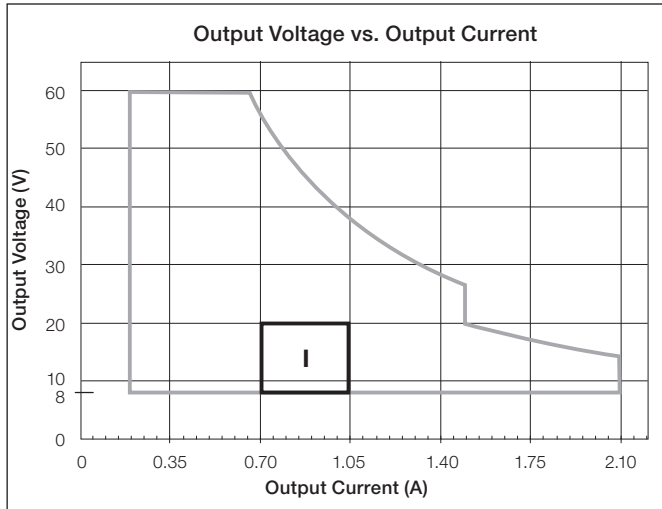

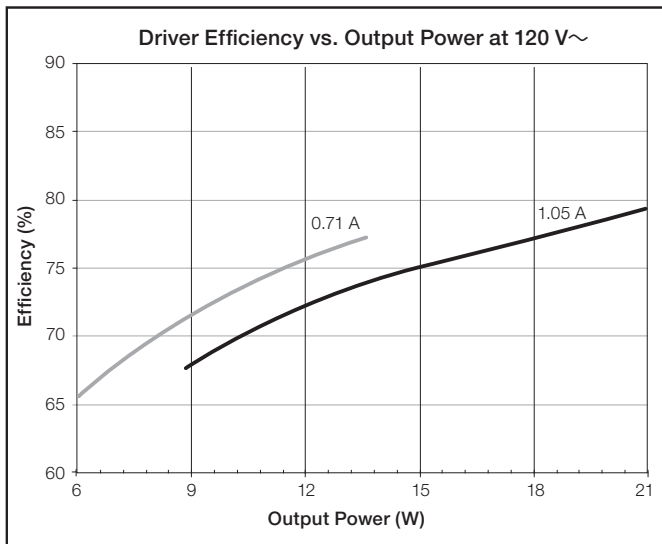

#### Typical Performance Specifications:

Parameter	Value	Test Conditions
Input Current	200 mA	$t_a = 25\text{ }^\circ\text{C}$ ,
Power Factor	0.99	1.05 A 21 W load,
THD	11%	Maximum Light Output,
Driver Efficiency	79%	K case 120 V $\sim$ without a dimmer



Job Name:	Model Numbers:
Job Number:	

### “J” Output Range, Current Driver Models

Driver Type	Output Dimming Method	Output Voltage	Output Current	Output Power	Standards Recognition	KL Case Option	Standards Recognition for KL Case
Constant-Current Driver (Class 2)	Pulse Width Modulation (PWM)	15–38 V PWM	0.71–1.05 A	11–40 W	 Type TL 82 °/68 °C - K-case Type TL 86 °/78 °C - M-case	Yes	
	Constant-Current Reduction (CCR)	15–38 V---					

When using QwikFig technology, these models can be built from the following bulk units:

K-case - LTEA4U1UKx-2SBLK\*; M-case - LTEA4U1UMN-2BBLK

\* x = studded (S) or non-studded (N)

#### Current Driver Operation Range:

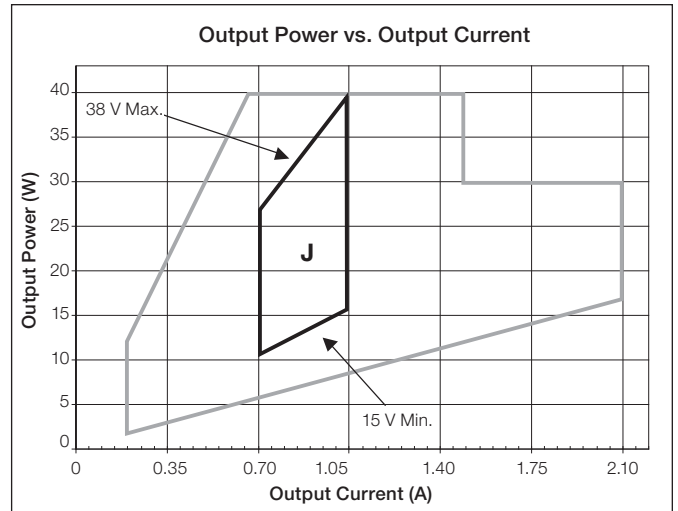
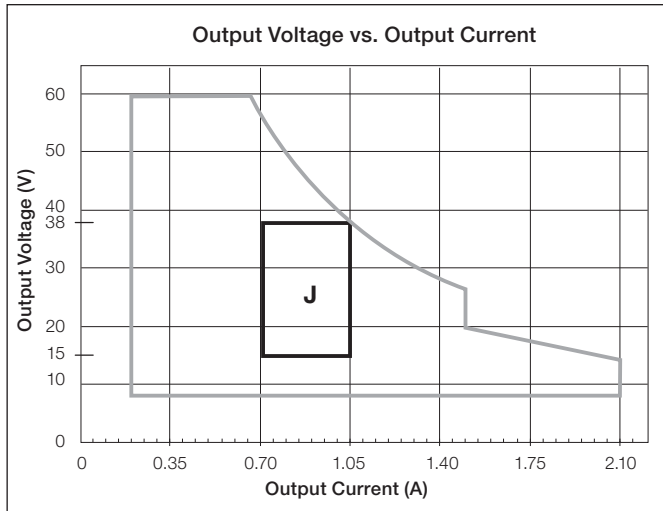

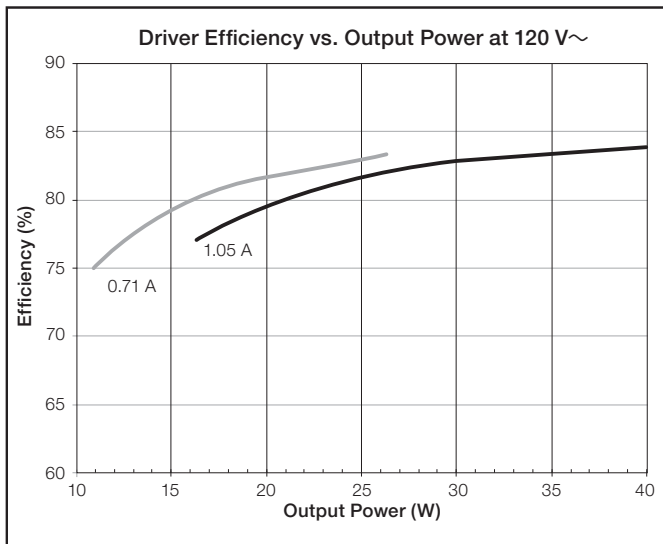

#### Typical Performance Specifications:

Parameter	Value	Test Conditions
Input Current	390 mA	$t_a = 25\text{ }^\circ\text{C}$ , 1.05 A 40 W load, Maximum Light Output, K case 120 V~ without a dimmer
Power Factor	0.99	
THD	7%	
Driver Efficiency	84%	



Job Name:	Model Numbers:
Job Number:	

### “K” Output Range, Current Driver Models

Driver Type	Output Dimming Method	Output Voltage	Output Current	Output Power	Standards Recognition	KL Case Option	Standards Recognition for KL Case
Constant-Current Driver (Class 2)	Pulse Width Modulation (PWM)	8–20 V PWM	1.06–1.50 A	9–30 W	 Type TL 80 °/74 °C - K-case Type TL 90 °/69 °C - M-case	Yes	
	Constant-Current Reduction (CCR)	8–20 V=					

When using QwikFig technology, these models can be built from the following bulk units:

K-case - LTEA4U1UKx-2RBLK\*; M-case - LTEA4U1UMN-2CBLK

\* x = studded (S) or non-studded (N)

#### Current Driver Operation Range:

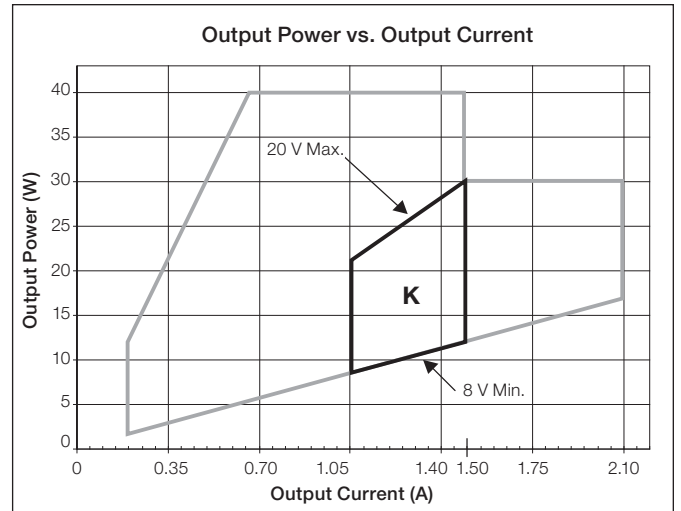
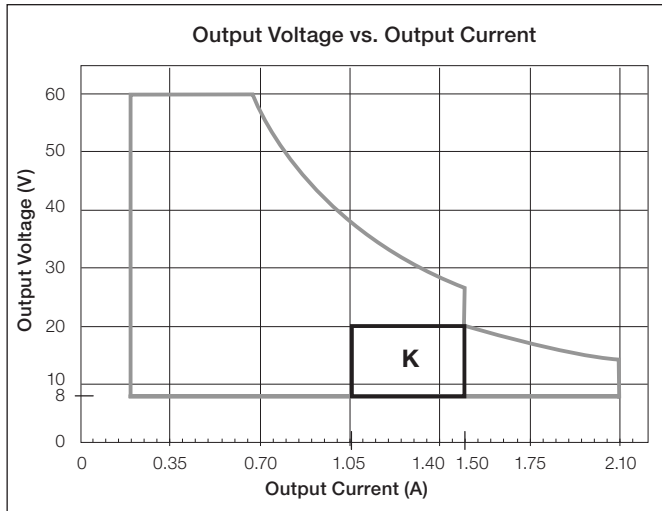

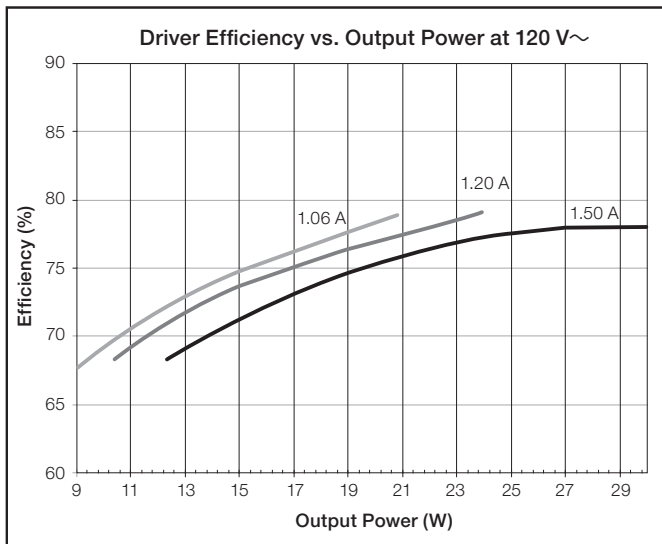

#### Typical Performance Specifications:

Parameter	Value	Test Conditions
Input Current	280 mA	t <sub>a</sub> = 25 °C, 1.50 A 30 W load, Maximum Light Output, K case 120 V~ without a dimmer
Power Factor	0.99	
THD	12%	
Driver Efficiency	79%	



Job Name:	Model Numbers:
Job Number:	

### “L” Output Range, Current Driver Models

Driver Type	Output Dimming Method	Output Voltage	Output Current	Output Power	Standards Recognition	KL Case Option	Standards Recognition for KL Case
Constant-Current Driver (Class 2)	Pulse Width Modulation (PWM)	15–38 V PWM	1.06–1.50 A	16–40 W	 Type TL 82 °/68 °C - K-case Type TL 86 °/78 °C - M-case	Yes	
	Constant-Current Reduction (CCR)	15–38 V---					

When using QwikFig technology, these models can be built from the following bulk units:

K-case - LTEA4U1UKx-2SBLK\*; M-case - LTEA4U1UMN-2BBLK

\* x = studded (S) or non-studded (N)

#### Current Driver Operation Range:

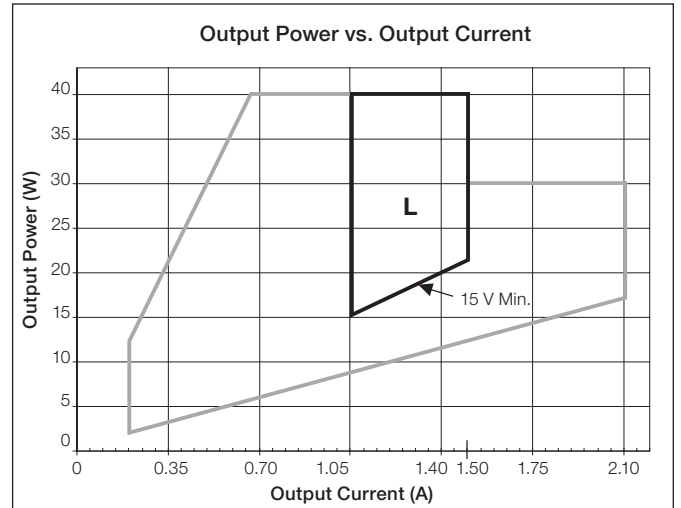
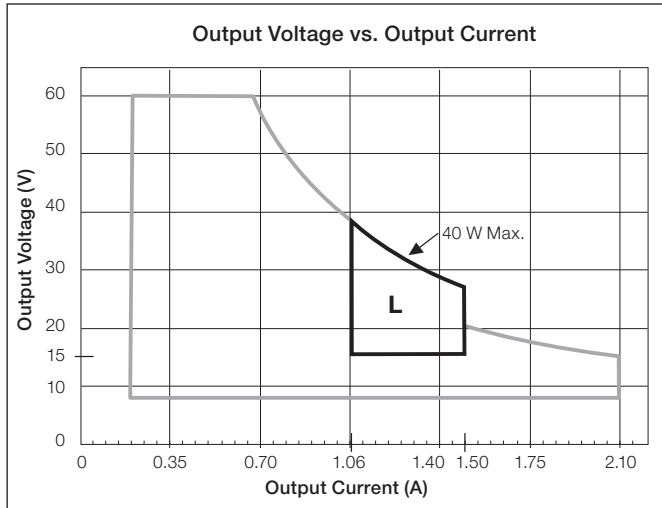

#### Typical Performance Specifications:

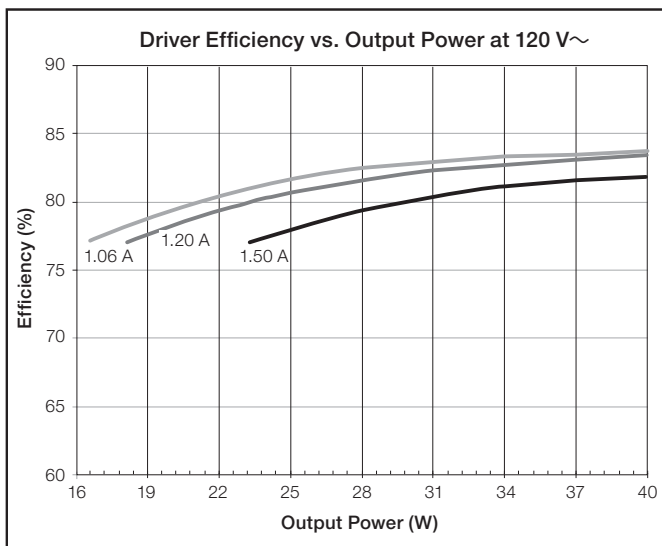

Parameter	Value	Test Conditions
Input Current	410 mA	$t_a = 25\text{ }^\circ\text{C}$ ,
Power Factor	0.99	1.50 A 40 W load,
THD	9%	Maximum Light Output,
Driver Efficiency	82%	K case
		120 V~ without a dimmer



Job Name:	Model Numbers:
Job Number:	



### “M” Output Range, Current Driver Models

Driver Type	Output Dimming Method	Output Voltage	Output Current	Output Power	Standards Recognition	KL Case Option	Standards Recognition for KL Case
Constant-Current Driver (Class 2)	Pulse Width Modulation (PWM)	8–19.9 V PWM	1.51–2.10 A	12–30 W	 Type TL 87 °/72 °C - K-case Type TL 90 °/73 °C - M-case	Yes	
	Constant-Current Reduction (CCR)	8–19.9 V=					

When using QwikFig technology, these models can be built from the following bulk units:

K-case - LTEA4U1UKx-2ABLK\*; M-case - LTEA4U1UMN-2ABLK

\* x = studded (S) or non-studded (N)

#### Current Driver Operation Range:

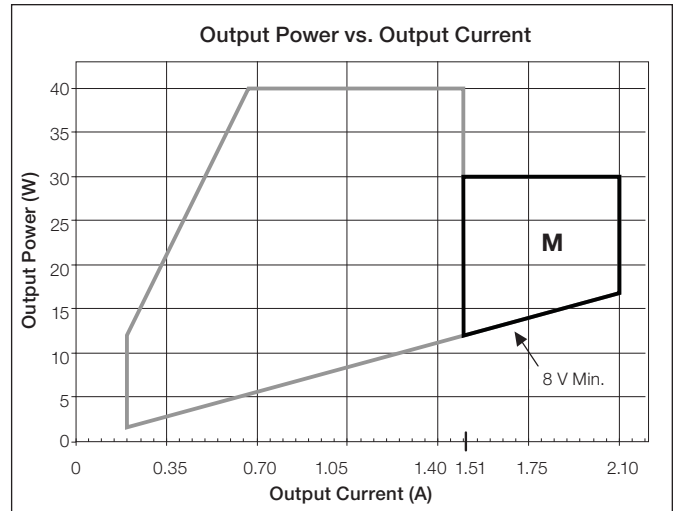
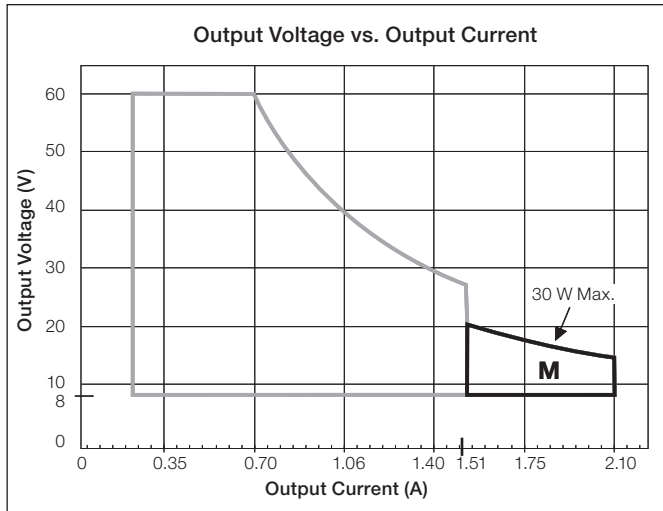

#### Typical Performance Specifications:

Parameter	Value	Test Conditions
Input Current	310 mA	$t_a = 25\text{ }^\circ\text{C}$ , 2.10 A 30 W load, Maximum Light Output, K case 120 V~ without a dimmer
Power Factor	0.99	
THD	14%	
Driver Efficiency	76%	

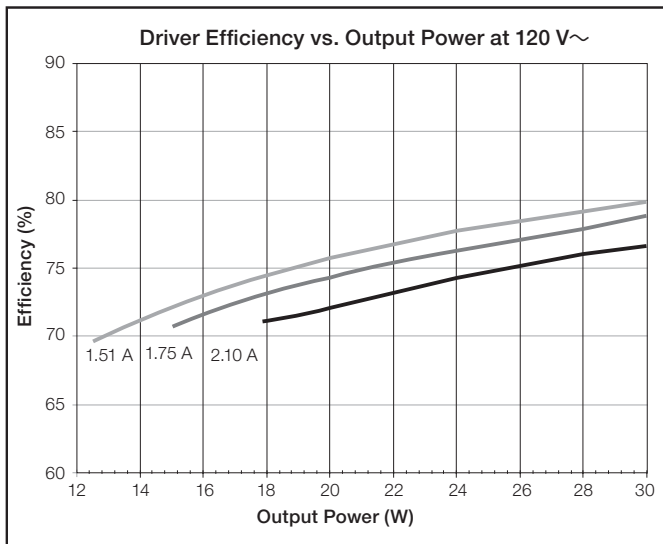

Job Name:	Model Numbers:
Job Number:	

## “X” Output Range, Voltage Driver Models

Driver Type	Output Dimming Method	Output Voltage	Output Current	Output Power	Standards Recognition	KL Case Option
Constant-Voltage Driver (Isolated, Non-Class 2)	Pulse Width Modulation (PWM)	38.5–60.0 V PWM	0.08–1.04 A	5–40 W		No

### Voltage Driver Operation Range:

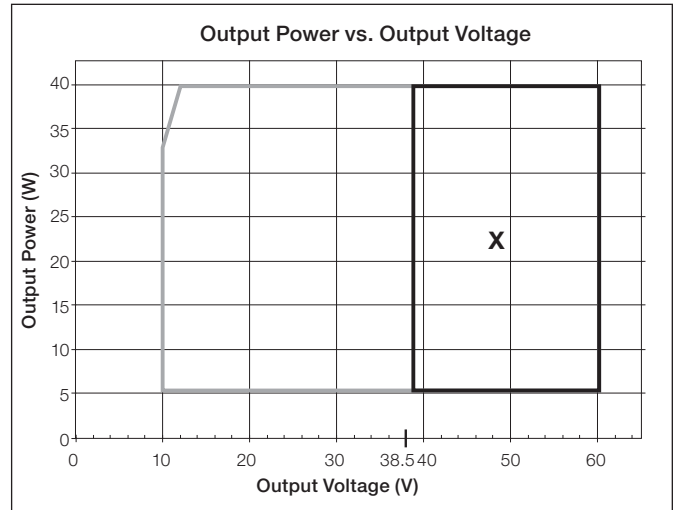
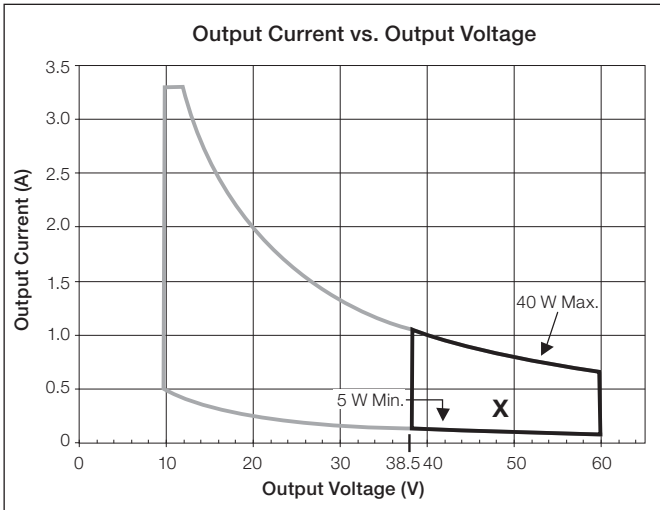

### Typical Performance Specifications:

Parameter	Value	Test Conditions
Input Current	390 mA	$t_a = 25\text{ }^\circ\text{C}$ , 60.0 V 40 W load, Maximum Light Output, K case 120 V~ without a dimmer
Power Factor	0.99	
THD	10%	
Driver Efficiency	86%	

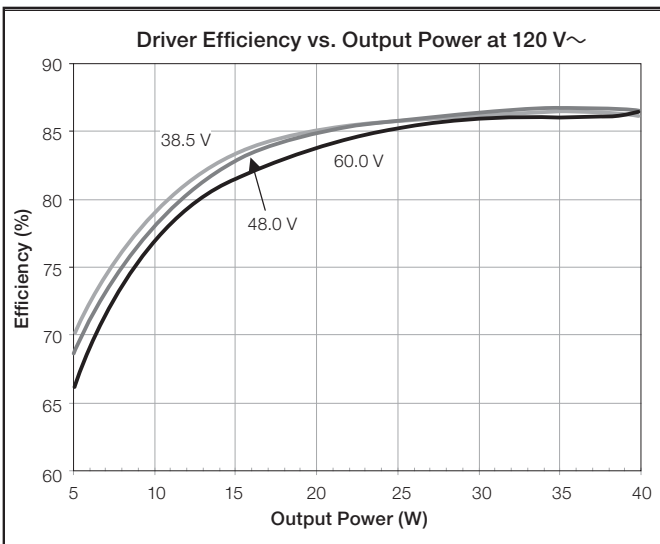

Job Name:	Model Numbers:
Job Number:	

## “Y” Output Range, Current Driver Models

Driver Type	Output Dimming Method	Output Voltage	Output Current	Output Power	Standards Recognition	KL Case Option
Constant-Current Driver (Isolated, Non-Class 2)	Pulse Width Modulation (PWM)	30–60 V PWM	0.20–0.50 A	6–30 W	 Type TL 80 °/72 °C - K-case Type TL 89 °/74 °C - M-case	No
	Constant-Current Reduction (CCR)	30–60 V $\sim$				

When using QwikFig technology, these models can be built from the following bulk units:

**K-case** - LTEA4U1UKx-1ABLK\*; **M-case** - LTEA4U1UMN-1ABLK

\* x = studded (S) or non-studded (N)

### Current Driver Operation Range:

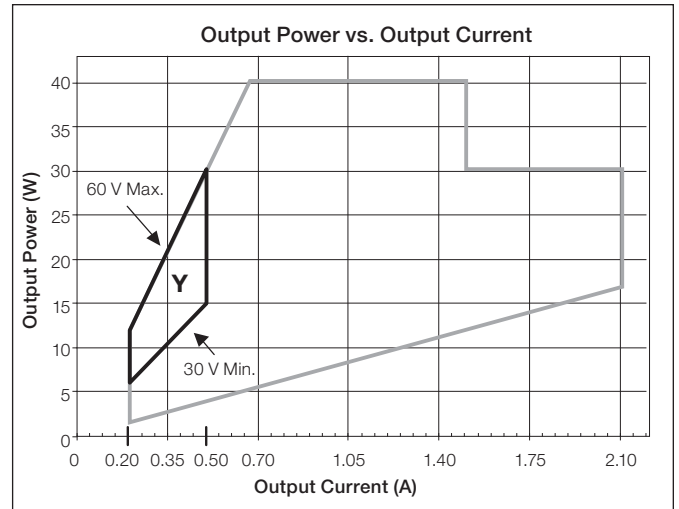
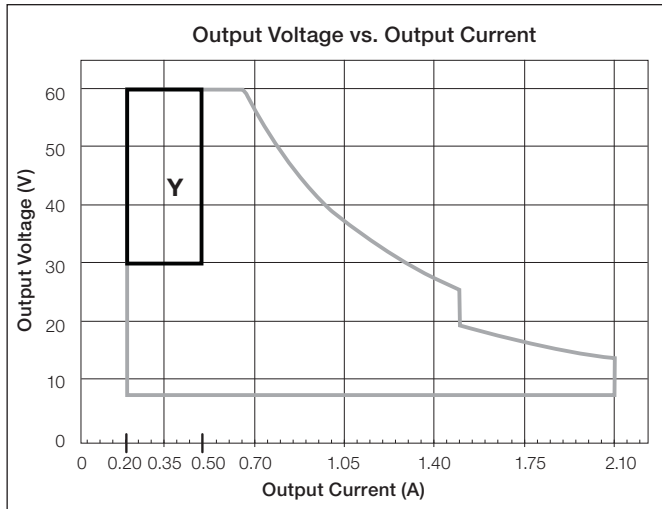

### Typical Performance Specifications:

Parameter	Value	Test Conditions
Input Current	290 mA	$t_a = 25\text{ }^\circ\text{C}$ , 0.50 A 30 W load, Maximum Light Output, K case 120 V $\sim$ without a dimmer
Power Factor	0.99	
THD	11%	
Driver Efficiency	84%	

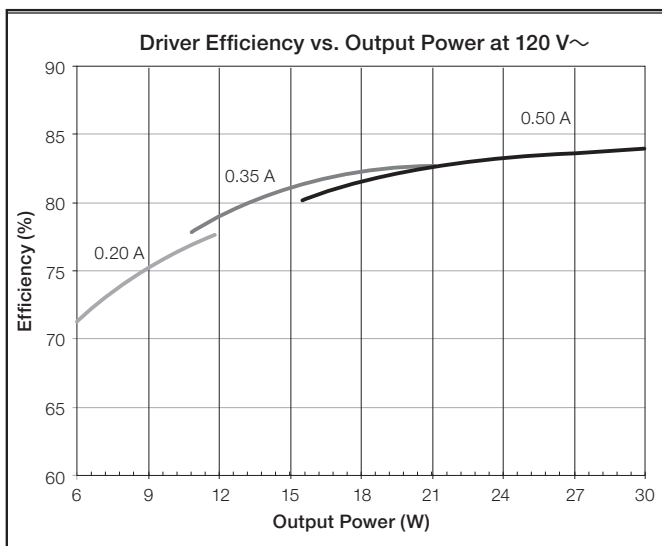

Job Name:	Model Numbers:
Job Number:	

## “Z” Output Range, Current Driver Models

Driver Type	Output Dimming Method	Output Voltage	Output Current	Output Power	Standards Recognition	KL Case Option
Constant-Current Driver (Isolated, Non-Class 2)	Pulse Width Modulation (PWM)	30–60 V PWM	0.51–1.00 A	16–40 W	 Type TL 80 °/72 °C - K-case Type TL 89 °/74 °C - M-case	No
	Constant-Current Reduction (CCR)	30–60 V ~				

When using QwikFig technology, these models can be built from the following bulk units:

**K-case** - LTEA4U1UKx-1ABLK\*; **M-case** - LTEA4U1UMN-1ABLK

\* x = studded (S) or non-studded (N)

### Current Driver Operation Range:

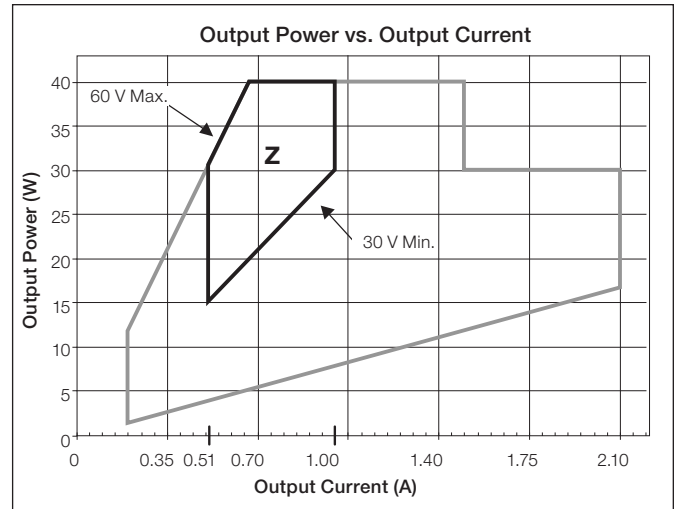
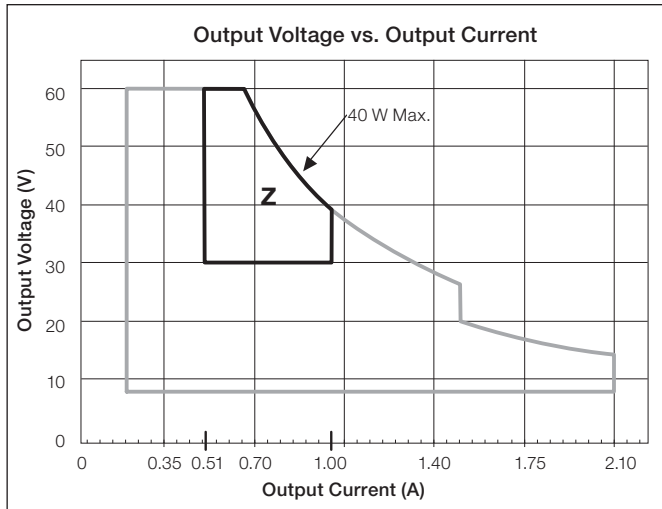

### Typical Performance Specifications:

Parameter	Value	Test Conditions
Input Current	410 mA	$t_a = 25\text{ }^\circ\text{C}$ ,
Power Factor	0.99	1.00 A 40 W load,
THD	8%	Maximum Light Output,
Driver Efficiency	83%	K case
		120 V~ without a dimmer

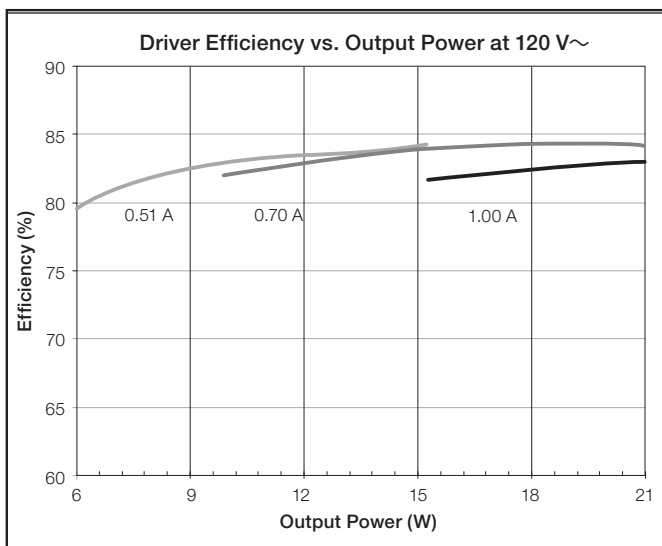

Job Name:	Model Numbers:
Job Number:	

## Bulk Model Coverage - K-Case Model Numbers

For use with Lutron QwikFig technology

### 3ABLK Operation Range:

Bulk Model	Driver Type	Output Dimming Method	Output Voltage	Output Current	Output Power	Standards Recognition
3ABLK	Constant-Current Driver (Class 2)	Constant-Current Reduction (CCR)	30–54 V <sub>DC</sub>	0.20–1.00 A	6–40 W	 Type TL 82 °/74 °C

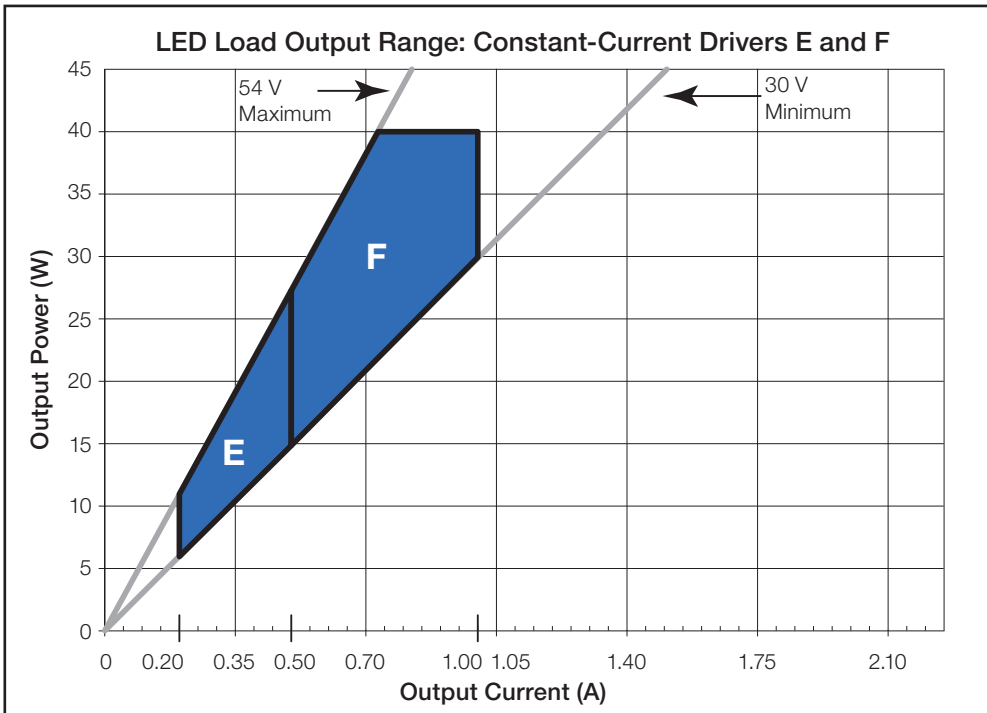



3A = Covers “LED Load Output Range” E and F (CCR dimming only)

Job Name:	Model Numbers:
Job Number:	

**Bulk Model Coverage - K-Case Model Numbers (continued)**  
 For use with Lutron QwikFig technology

**2HBLK and 2SBLK Operation Range:**

Bulk Model	Driver Type	Output Dimming Method	Output Voltage	Output Current	Output Power	Standards Recognition
2HBLK	Constant-Current Driver (Class 2)	Pulse Width Modulation (PWM)	15–38 V PWM	0.20–0.70 A	3–26.6 W	 Type TL 84 °/62 °C
		Constant-Current Reduction (CCR)	15–38 V==			
2SBLK	Constant-Current Driver (Class 2)	Pulse Width Modulation (PWM)	15–38 V PWM	0.71–1.50 A	11–40 W	 Type TL 82 °/68 °C
		Constant-Current Reduction (CCR)	15–38 V==			

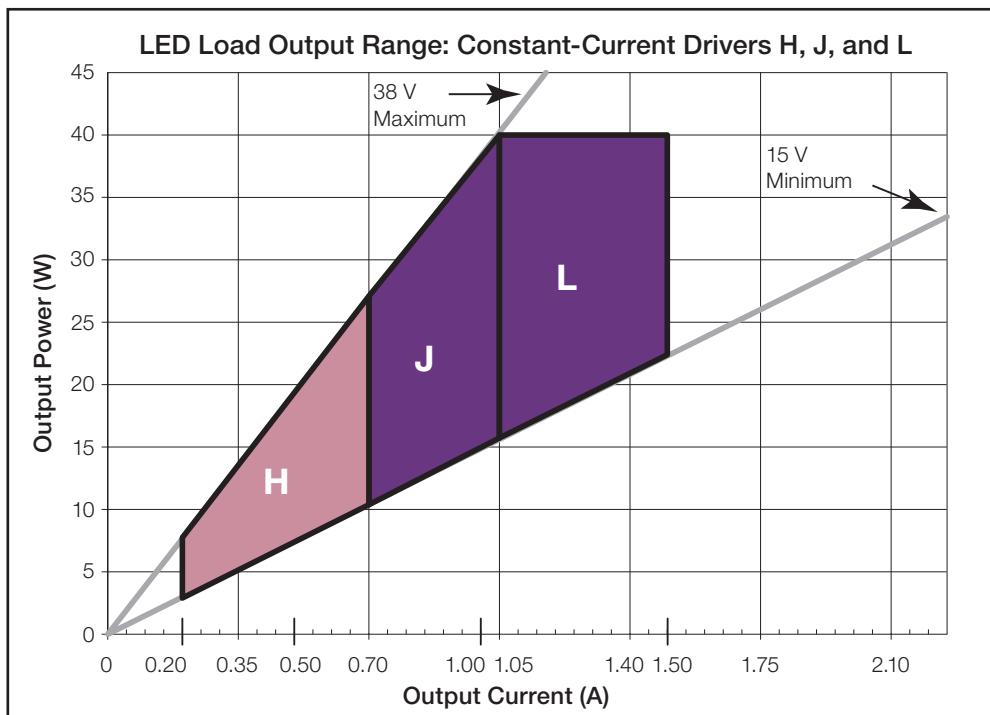



2H = Covers “LED Load Output Range” H  
 2S = Covers “LED Load Output Range” J and L

Job Name:	Model Numbers:
Job Number:	

**Bulk Model Coverage - K-Case Model Numbers (continued)**  
 For use with Lutron QwikFig technology

**2GBLK, 2RBLK, and 2ABLK Operation Range:**

Bulk Model	Driver Type	Output Dimming Method	Output Voltage	Output Current	Output Power	Standards Recognition
2GBLK	Constant-Current Driver (Class 2)	Pulse Width Modulation (PWM)	8–20 V PWM	0.20–0.70 A	2–14 W	 Type TL 86 °/57 °C
		Constant-Current Reduction (CCR)	8–20 V=			
2RBLK	Constant-Current Driver (Class 2)	Pulse Width Modulation (PWM)	8–20 V PWM	0.71–1.50 A	6–30 W	 Type TL 80 °/74 °C
		Constant-Current Reduction (CCR)	8–20 V=			
2ABLK	Constant-Current Driver (Class 2)	Pulse Width Modulation (PWM)	8–19.9 V PWM	1.51–2.10 A	12–30 W	 Type TL 87 °/72 °C
		Constant-Current Reduction (CCR)	8–19.9 V=			

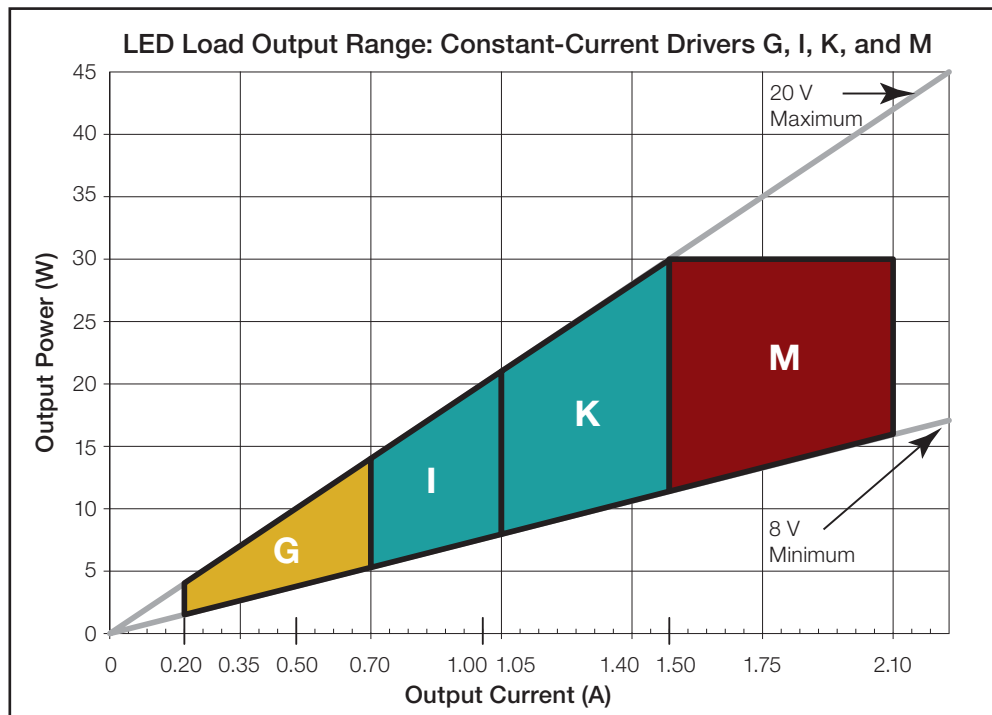

- 2G = Covers “LED Load Output Range” G
- 2R = Covers “LED Load Output Range” I and K
- 2A = Covers “LED Load Output Range” M

Job Name:	Model Numbers:
Job Number:	

**Bulk Model Coverage - K-Case Model Numbers (continued)**  
 For use with Lutron QwikFig technology

**1ABLK Operation Range:**

Bulk Model	Driver Type	Output Dimming Method	Output Voltage	Output Current	Output Power	Standards Recognition
1ABLK	Constant-Current Driver (Isolated, Non-Class 2)	Pulse Width Modulation (PWM)	30–60 V PWM	0.20–1.00 A	6–40 W	 Type TL 80 °/72 °C
		Constant-Current Reduction (CCR)	30–60 V==			

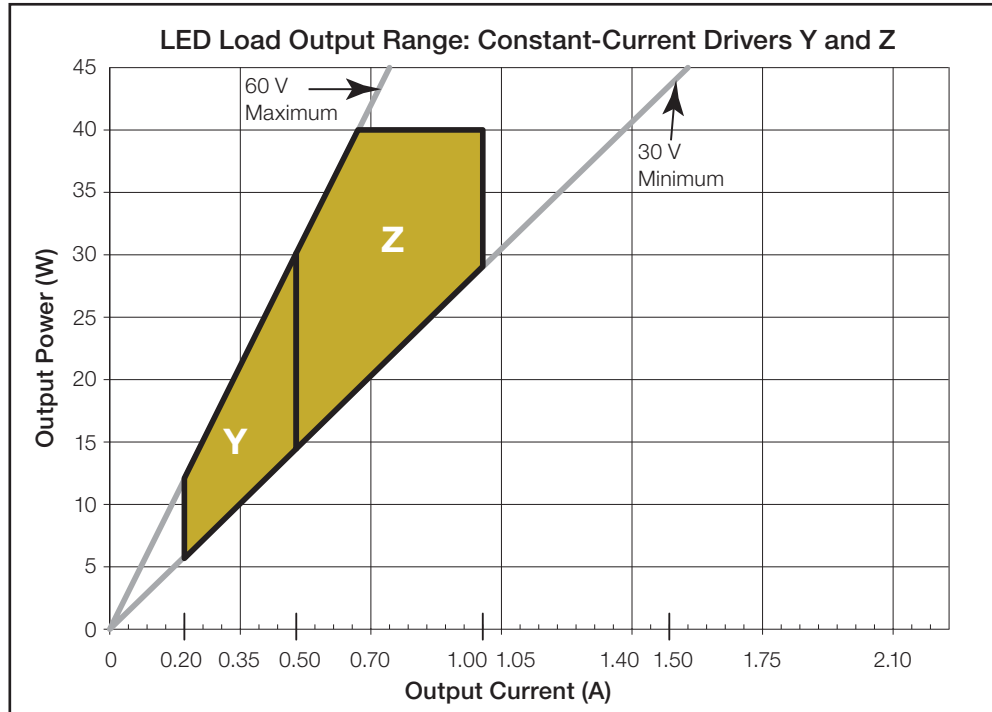

1A = Covers “LED Load Output Range” Y and Z

Job Name:	Model Numbers:
Job Number:	



## Bulk Model Coverage - M-Case Model Numbers

For use with Lutron QwikFig technology

### 3ABLK Operation Range:

Bulk Model	Driver Type	Output Dimming Method	Output Voltage	Output Current	Output Power	Standards Recognition
3ABLK	Constant-Current Driver (Class 2)	Constant-Current Reduction (CCR)	30–54 V <sub>DC</sub>	0.20–1.00 A	6–40 W	 Type TL 86 °/72 °C

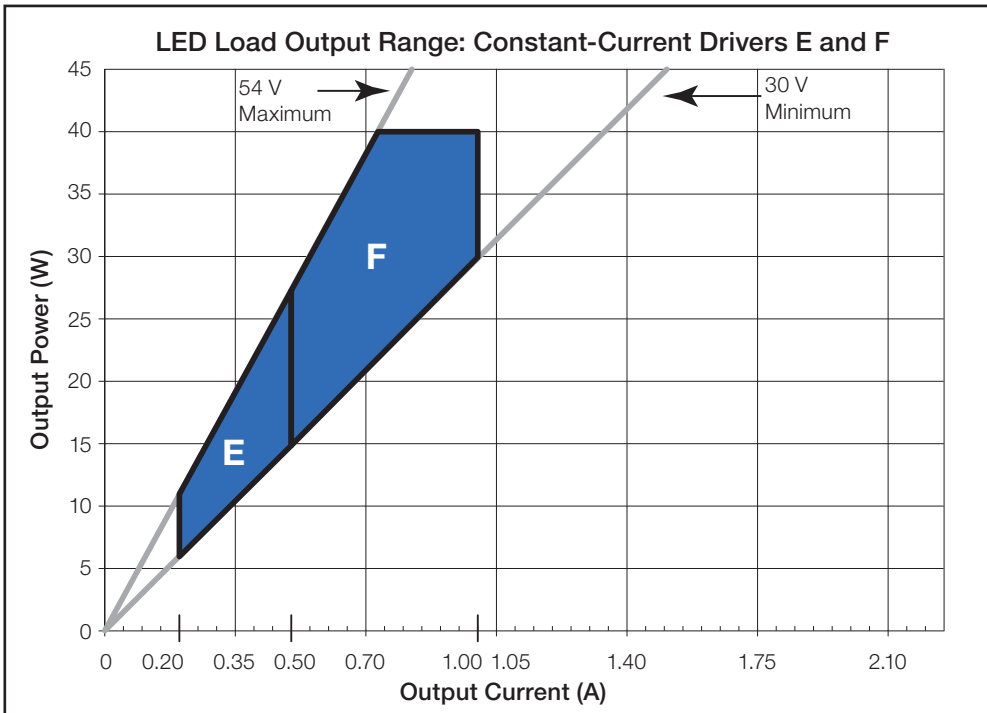

3A = Covers “LED Load Output Range” E and F (CCR dimming only)

Job Name:	Model Numbers:
Job Number:	

**Bulk Model Coverage - M-Case Model Numbers (continued)**  
 For use with Lutron QwikFig technology

**2BBLK Operation Range:**

Bulk Model	Driver Type	Output Dimming Method	Output Voltage	Output Current	Output Power	Standards Recognition
2BBLK	Constant-Current Driver (Class 2)	Pulse Width Modulation (PWM)	15–38 V PWM	0.20–1.50 A	3–40 W	 Type TL 86 °/78 °C
		Constant-Current Reduction (CCR)	15–38 V==			

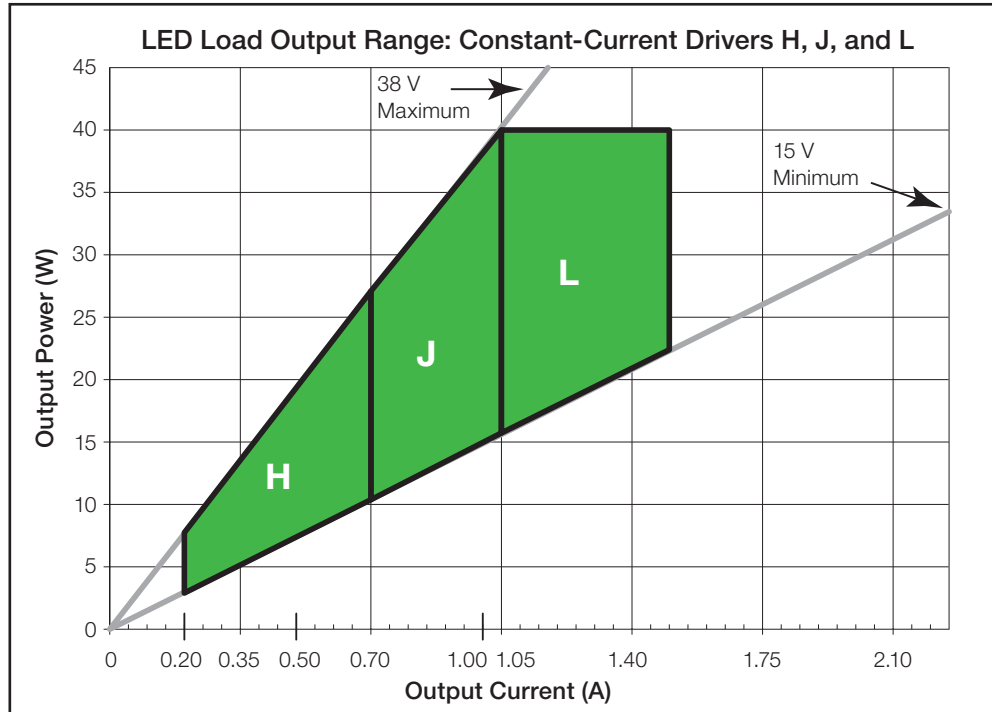



2B = Covers “LED Load Output Range” H, J, and L

Job Name:	Model Numbers:
Job Number:	

**Bulk Model Coverage - M-Case Model Numbers (continued)**  
 For use with Lutron QwikFig technology

**2CBLK and 2ABLK Operation Range:**

Bulk Model	Driver Type	Output Dimming Method	Output Voltage	Output Current	Output Power	Standards Recognition
2CBLK	Constant-Current Driver (Class 2)	Pulse Width Modulation (PWM)	8–20 V PWM	0.20–1.50 A	2–30 W	 Type TL 90 °/69 °C
		Constant-Current Reduction (CCR)	8–20 V=			
2ABLK	Constant-Current Driver (Class 2)	Pulse Width Modulation (PWM)	8–19.9 V PWM	1.51–2.10 A	12–30 W	 Type TL 90 °/73 °C
		Constant-Current Reduction (CCR)	8–19.9 V=			

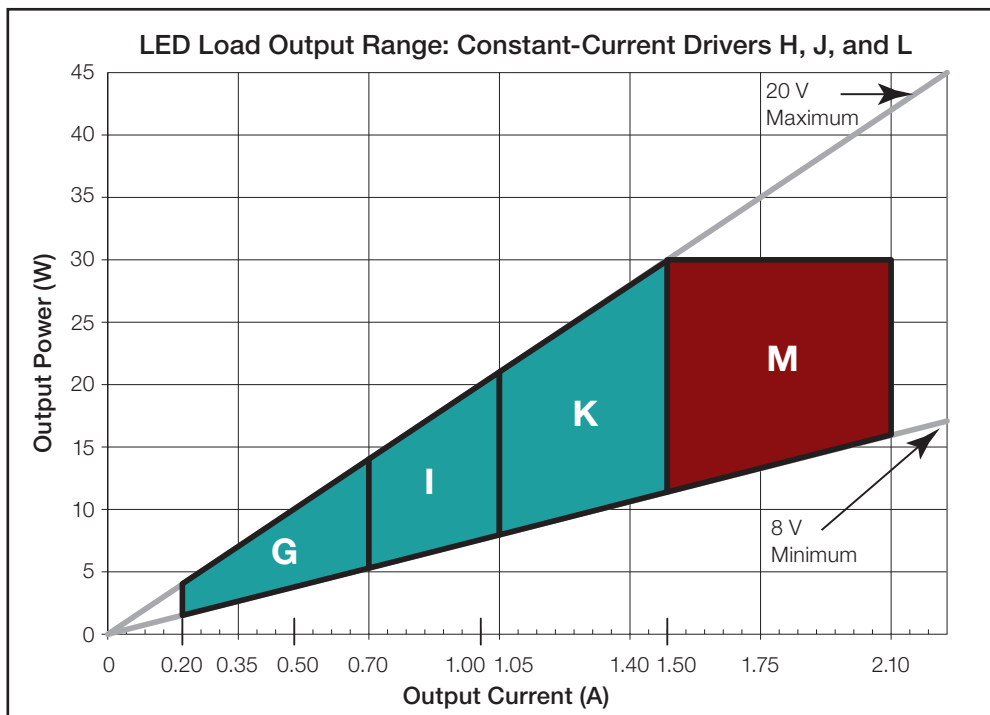

2C = Covers “LED Load Output Range” G, I, and K  
 2A = Covers “LED Load Output Range” M

Job Name:	Model Numbers:
Job Number:	

**Bulk Model Coverage - M-Case Model Numbers (continued)**  
 For use with Lutron QwikFig technology

**1ABLK Operation Range:**

Bulk Model	Driver Type	Output Dimming Method	Output Voltage	Output Current	Output Power	Standards Recognition
1ABLK	Constant-Current Driver (Isolated, Non-Class 2)	Pulse Width Modulation (PWM)	30–60 V PWM	0.20–1.00 A	6–40 W	 Type TL 89 °/74 °C
		Constant-Current Reduction (CCR)	30–60 V==			

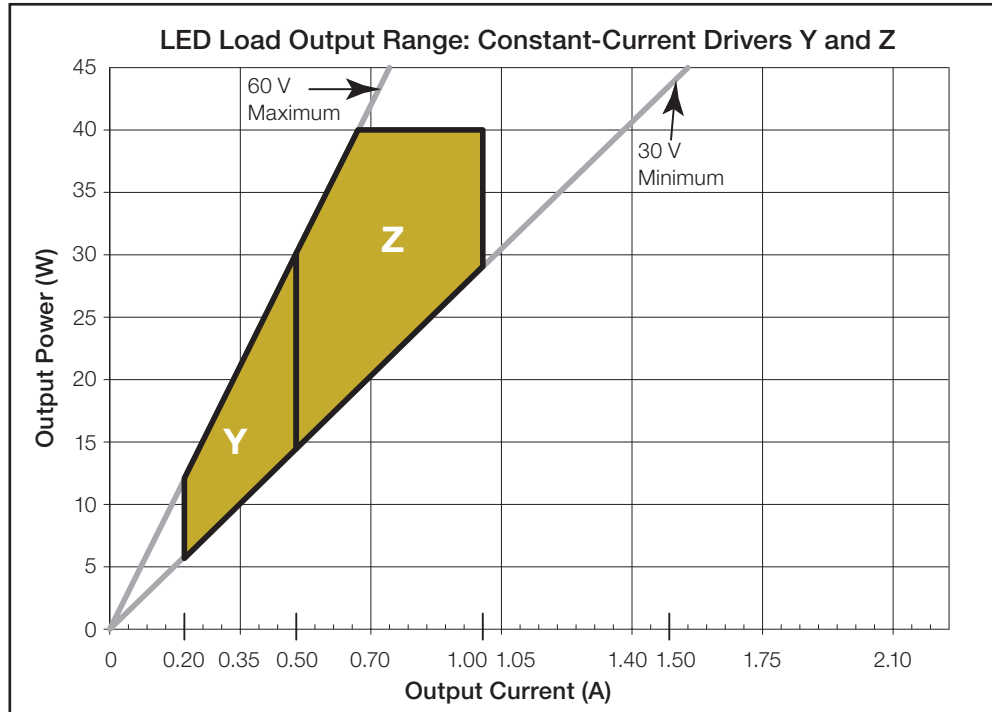

1A = Covers “LED Load Output Range” Y and Z

Job Name:	Model Numbers:
Job Number:	

**K Case: Case Dimensions**

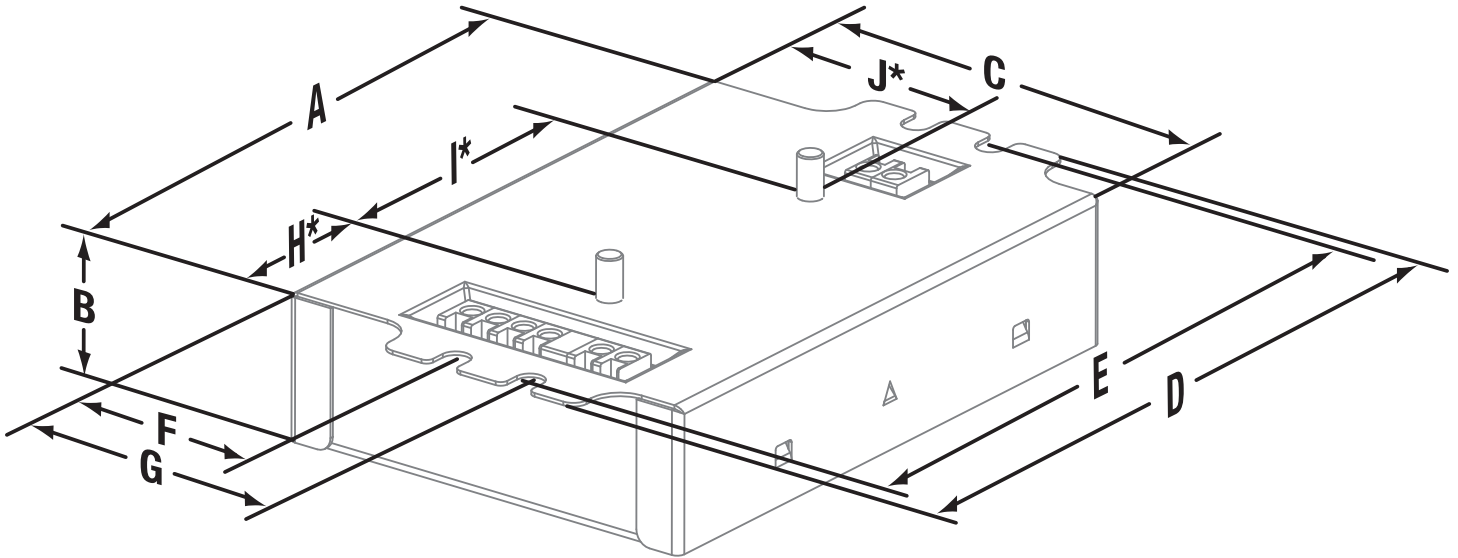

**K Case: Connector Location Dimensions**

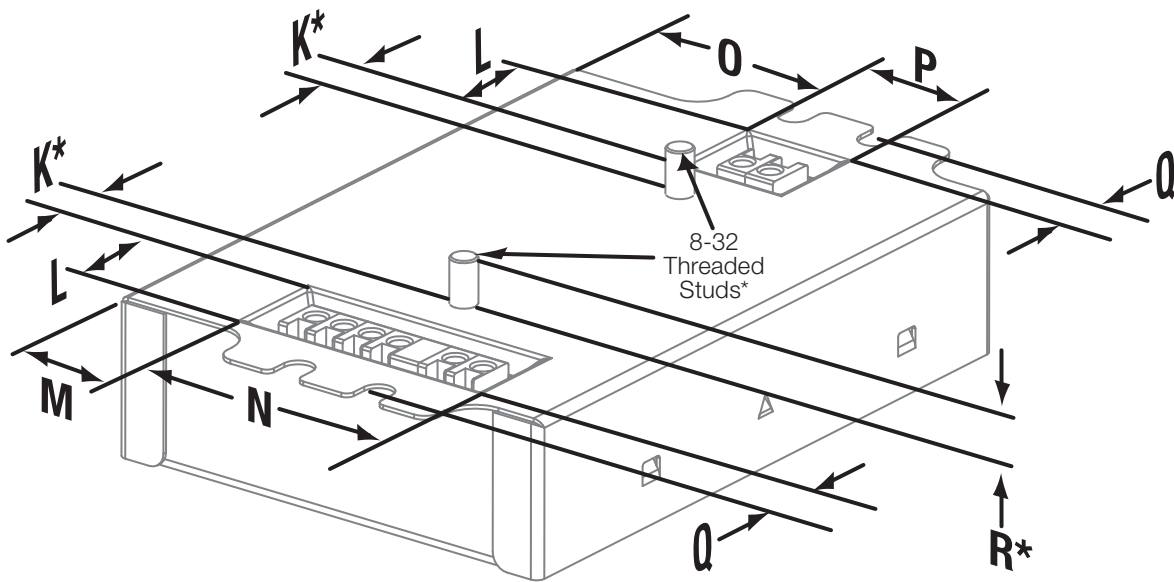

A	4.20 in (107 mm)	F	1.42 in (36 mm)	K*	0.33 in (8.3 mm)	P	0.74 in (19 mm)
B	1.00 in (25 mm)	G	1.99 in (51 mm)	L	0.65 in (16.5 mm)	Q	0.32 in (8 mm)
C	3.00 in (76 mm)	H*	1.11 in (28 mm)	M	0.75 in (19 mm)	R*	0.29 in (7 mm)
D	4.90 in (124 mm)	I*	2.00 in (51 mm)	N	1.73 in (44 mm)		
E	4.60 in (117 mm) (mounting center)	J*	1.60 in (41 mm)	O	1.33 in (34 mm)		

\* Applies to studded K case only.

Job Name:	Model Numbers:
Job Number:	

### K Case: Side Entry Connector Location Dimensions (Non-Studded)

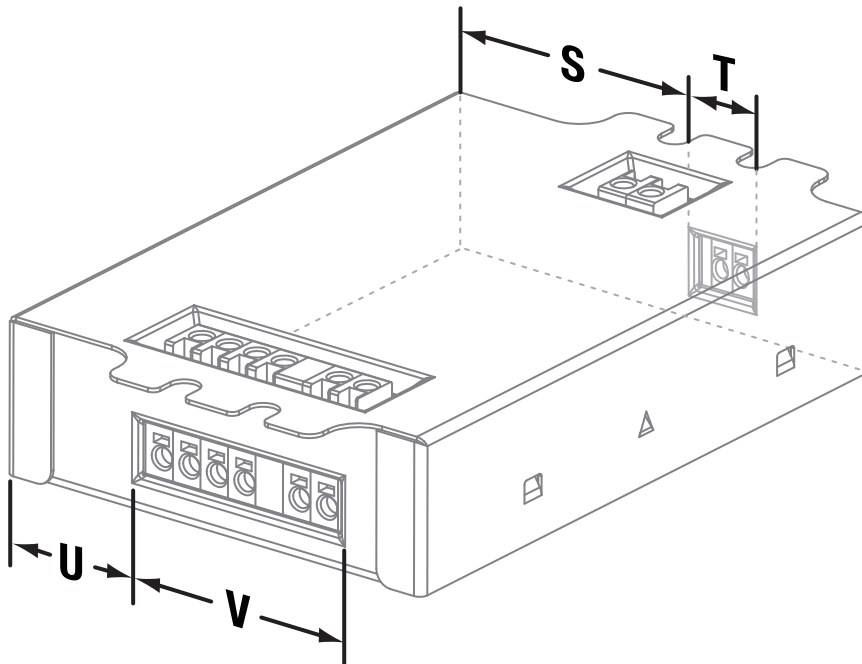

- S 1.38 in (35 mm)
- T 0.64 in (16 mm)
- U 0.88 in (22 mm)
- V 1.53 in (39 mm)

### M Case: Case Dimensions

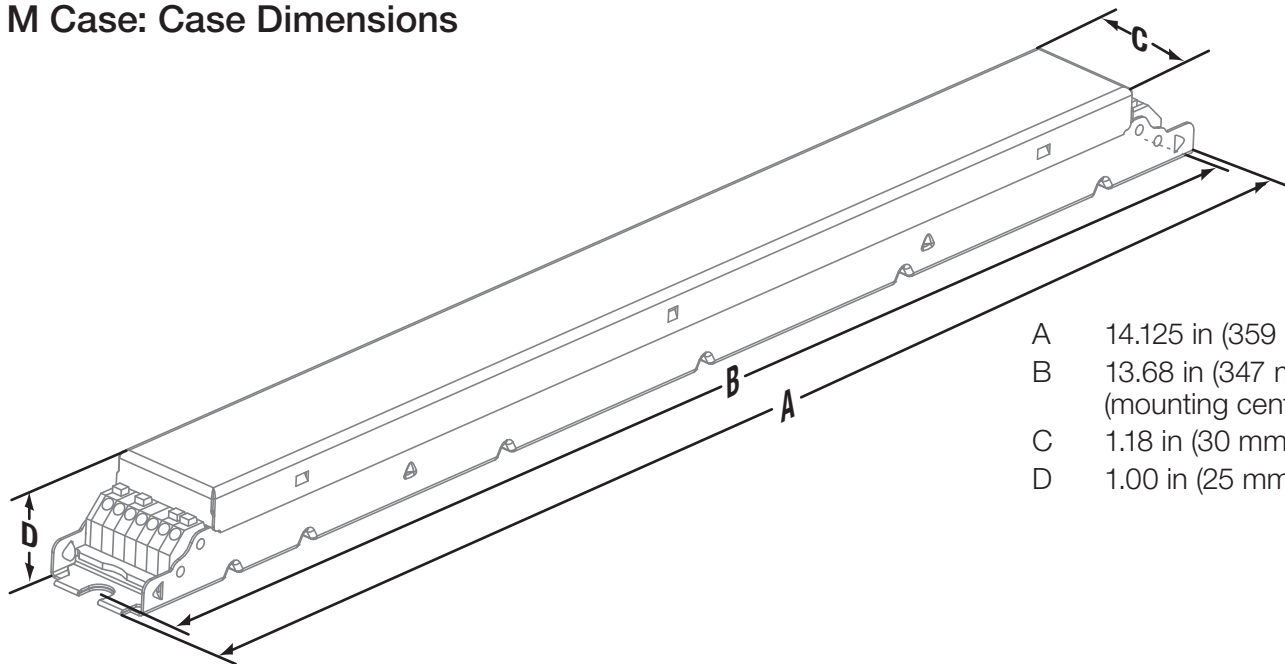

- A 14.125 in (359 mm)
- B 13.68 in (347 mm)  
(mounting center)
- C 1.18 in (30 mm)
- D 1.00 in (25 mm)

Job Name:	Model Numbers:
Job Number:	

## KL Case: Case Dimensions

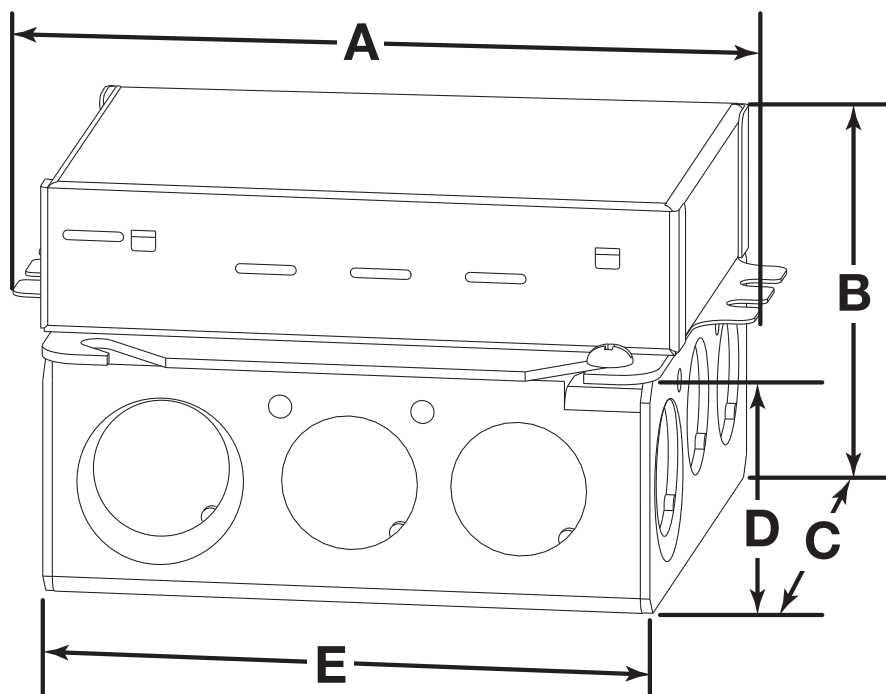

A	4.89 in (124 mm)
B	2.62 in (66 mm)
C	4.00 in (102 mm)
D	1.62 in (41 mm)
E	4.00 in (102 mm)

KL case includes a 4 in (102 mm) square junction box which complies with NEMA OS 1-2008 Figure 112.

### Knockouts

- Sides
  - 8 locations: 0.5 in (13 mm)
  - 4 locations: 0.5/0.75 in (13/19 mm)
- Bottom
  - 2 locations: 0.5 in (13 mm)
  - 2 locations: 0.5/0.75 in (13/19 mm)

### Driver Wiring and Mounting

- Driver is grounded by the green ground wire connection on the enclosure or by the ground lug terminal in the junction box
- Driver and junction box must be grounded in accordance with local and national electrical codes
- All wire connections must be made in the junction box to maintain UL listing
- 4 in (102 mm) square junction box is 1.5 in (38 mm) deep with 22.0 in<sup>3</sup> (360.5 cm<sup>3</sup>) capacity and complies with NEMA OS 1-2008 Figure 112
- Driver is pre-wired with 6 in (152 mm), 18 AWG (0.75 mm<sup>2</sup>) solid copper leads in all terminal blocks

Job Name:	Model Numbers:
Job Number:	

## Wiring

### Controls Requiring Neutral

**Note:** Colors shown correspond to terminals on driver.

### Wiring Diagram

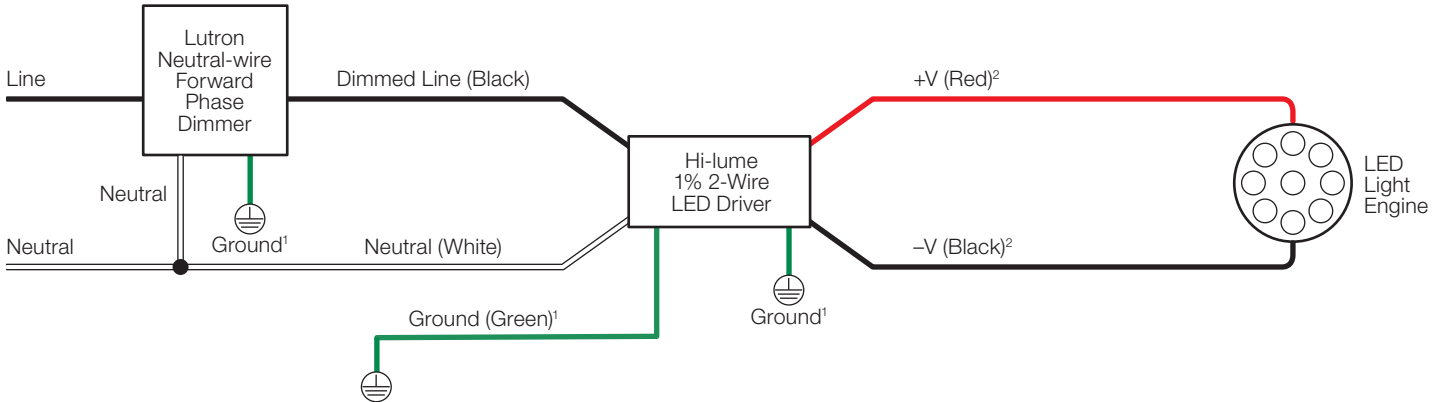

<sup>1</sup>Ground wire connection available on K case models only. Fixture and driver case must be grounded in accordance with local and national electrical codes.

<sup>2</sup>For maximum driver-to-LED light engine wire length, see charts in **Driver Leads** section at the end of the document.

### Compatible Controls: Lutron Neutral-wire Dimmers

Guaranteed performance specifications with the controls listed in the chart below.

For assistance selecting controls, contact our LED Center of Excellence at 1.877.346.5338 or LEDs@lutron.com

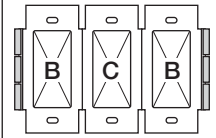
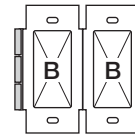
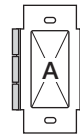

Product	Part Number	Low-End Setting/Load-Type Setting <sup>1</sup>	Drivers per Control		
			A: Not Ganged	B: End of Gang	C: Middle of Gang
Maestro Wireless 600 W dimmer	MRF2-6ND-120-	Trim low-end per APM App Note (Lutron P/N 048370)	1–8	1–8	1–8
Caséta Wireless Pro 1000 W dimmer	PD-10NXD-	Trim low-end per instructions at www.casetawireless.com/lowend	1–13	1–13	1–13
GRAFIK T C•L dimmer	GT-250M-GTJ-250M-	Set low-end trim per dimmer installation instructions	1–10	1–10	1–10
HomeWorks QS adaptive dimmer	HQRD-6NA-	“Hi-lume 1% 2-Wire LTE LED” <sup>2</sup>	1–8	1–8	1–8
HomeWorks QS 600 W dimmer	HQRD-6ND-	“Hi-lume 1% 2-Wire LTE LED” <sup>2</sup>	1–8	1–8	1–8
HomeWorks QS 1000 W dimmer	HQRD-10ND-	“Hi-lume 1% 2-Wire LTE LED” <sup>2</sup>	1–13	1–13	1–13
RadioRA 2 adaptive dimmer	RRD-6NA-	“Hi-lume 1% 2-Wire LTE LED” <sup>2</sup>	1–8	1–8	1–8
RadioRA 2 1000 W dimmer	RRD-10ND-	Set Device type to “INC/MLV Neutral Dimmer”; Set High-End Trim to 99%; Set Low-End Trim to 35%	1–13	1–13	1–13

<sup>1</sup>Setting the low-end trim and load type is necessary to ensure optimal performance and 1% dimming capability.

Note: For information about Legacy Product use in existing control application, contact LEDs@lutron.com

<sup>2</sup>Also listed as “LED Lutron A-Series 2-Wire” or “Hi-lume A-Series LTE LED Driver 2-Wire” in previous software releases.

<b>Job Name:</b>	<b>Model Numbers:</b>
<b>Job Number:</b>	



**Wiring** (continued)

**Controls Requiring Neutral** (continued)

**Note:** Colors shown correspond to terminals on driver.

**Wiring Diagram**

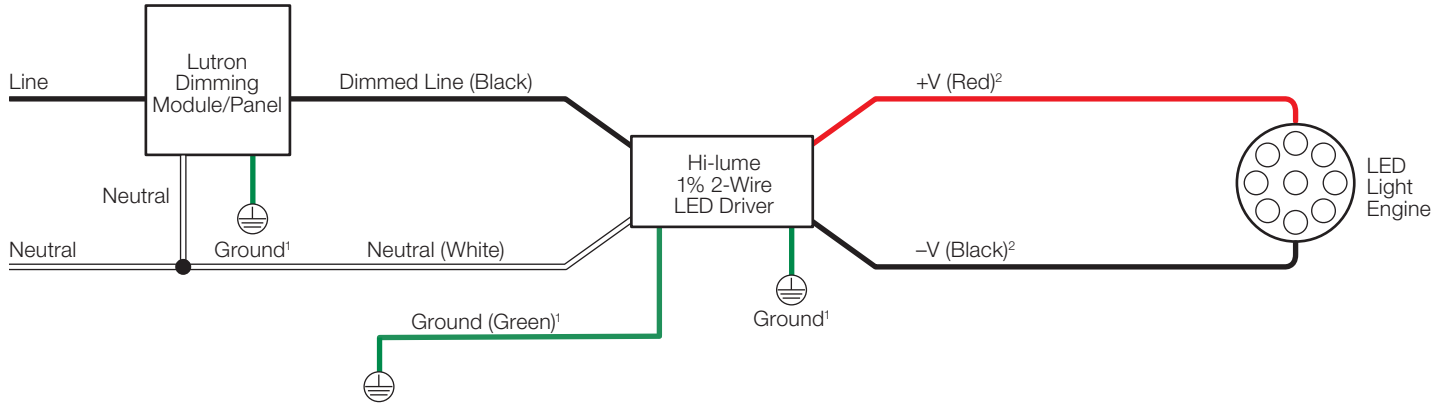

<sup>1</sup> Ground wire connection available on K case models only. Fixture and driver case must be grounded in accordance with local and national electrical codes.

<sup>2</sup> For maximum driver-to-LED light engine wire length, see charts in **Driver Leads** section at the end of the document.

**Compatible Controls: Lutron Dimming Modules/Panels**

Guaranteed performance specifications with the controls listed in the chart below.

For assistance selecting controls, contact our LED Center of Excellence at 1.877.346.5338 or LEDs@lutron.com

Product	Part Number	Drivers per Control	Low-End Setting/Load-Type Setting <sup>1</sup>
myRoom DIN power module	MQSE-4A1-D	1–6 (per output); 1 A maximum driver input current	“Hi-lume 1% 2-Wire LTE LED” <sup>2</sup>
HomeWorks QS DIN power module	LQSE-4A1-D	1–6 (per output); 1 A maximum driver input current	“Hi-lume 1% 2-Wire LTE LED” <sup>2</sup>
HomeWorks QS wallbox power module	HQRJ-WPM-6D-120	2–10 (per output); 26 total per module	“Hi-lume 1% 2-Wire LTE LED” <sup>2</sup>
HomeWorks wallbox power module	HWI-WPM-6D-120	2–10 (per output); 26 total per module	Set load type to “GRX-FDBI” or “GRX-TVI”
GRAFIK Eye QS control unit	QSGR-, QSGRJ-	2–10 (per output); 26 total per unit	Set load type to “Fluorescent Module”
GRAFIK Eye 3000 control unit	GRX-3100-, GRX-3500-	2–10 (per output); 26 total per module	Set load type to “GRX-FDBI” or “GRX-TVI”
RPM-4U module (LCP, HomeWorks QS, GRAFIK Systems, Quantum)	HW-RPM-4U-120, LP-RPM-4U-120	2–26 (per output); 26 total per module	“Hi-lume 1% 2-Wire LTE LED” <sup>2</sup> Set load type to “2-1”
RPM-4A module (LCP, HomeWorks QS, GRAFIK Systems, Quantum)	HW-RPM-4A-120, LP-RPM-4A-120	1–13 (per output); 26 total per module	“Hi-lume 1% 2-Wire LTE LED” <sup>2</sup> Set load type to “2-1”
GP dimming panels	Various	1–26	Set load type to “2-1”

<sup>1</sup> Setting the low-end trim and load type is necessary to ensure optimal performance and 1% dimming capability.

<sup>2</sup> Also listed as “LED Lutron A-Series 2-Wire” or “Hi-lume A-Series LTE LED Driver 2-Wire” in previous software releases.

<b>Job Name:</b>	<b>Model Numbers:</b>
<b>Job Number:</b>	

Wiring (continued)

Controls Not Requiring Neutral

Note: Colors shown correspond to terminals on driver.

Wiring Diagram

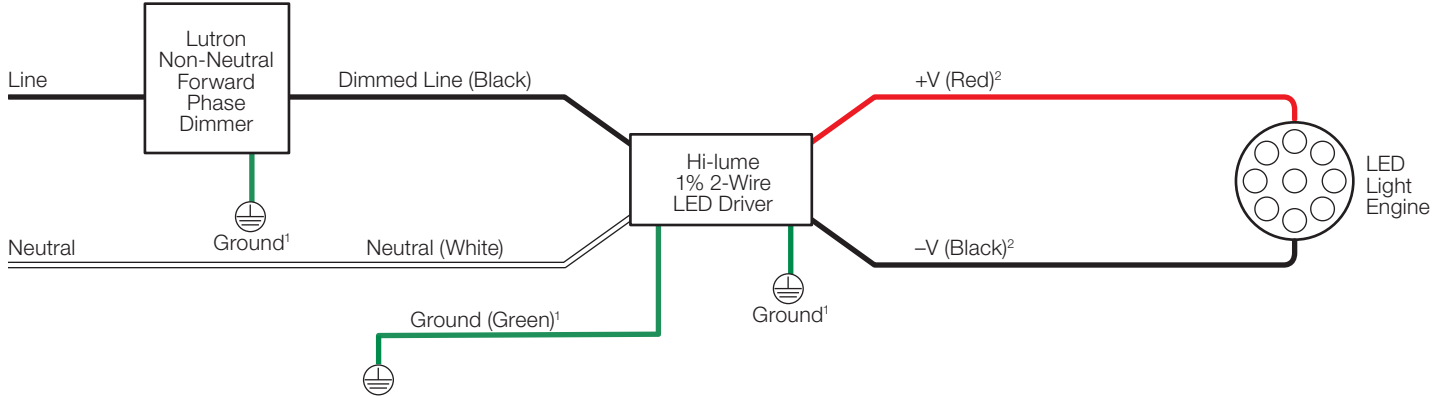

<sup>1</sup> Ground wire connection available on K case models only. Fixture and driver case must be grounded in accordance with local and national electrical codes.

<sup>2</sup> For maximum driver-to-LED light engine wire length, see charts in **Driver Leads** section at the end of the document.

Compatible Controls: Lutron Non-Neutral Dimmers

Guaranteed performance specifications with the controls listed in the chart below.

For assistance selecting controls, contact our LED Center of Excellence at 1.877.346.5338 or LEDs@lutron.com

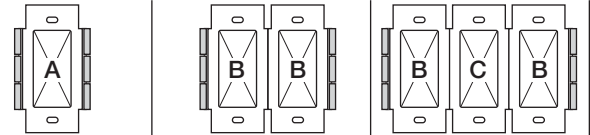

Product	Part Number	Low-End Setting/ Load-Type Setting*	Drivers per Control		
			A: Not Ganged	B: End of Gang	C: Middle of Gang
Ariadni C•L 250 W dimmer	AYCL-253P-	Set low-end trim dial to 1 o'clock. Adjust slightly if needed. See Figure 1 under 'Dimmer Range Adjustment' section in the Dimmer Installation Guide for how to adjust low-end trim	1-8	1-8	1-8
Diva C•L 250 W dimmer	DVCL-253P- DVSCCL-253P-	Set low-end trim dial to 10 o'clock. Adjust slightly if needed. See Figure 1 under 'Dimmer Range Adjustment' section in the Dimmer Installation Guide for how to adjust low-end trim	1-8	1-8	1-8
Nova T★ C•L 250 W dimmer	NTCL-250-	Set low-end trim per dimmer installation instructions	1-10	1-10	1-10

\*Setting the low-end trim and load type is necessary to ensure optimal performance and 1% dimming capability.

Note: For information about Legacy Product use in existing control application, contact LEDs@lutron.com

<b>Job Name:</b>	<b>Model Numbers:</b>
<b>Job Number:</b>	

### Terminal Wiring Gauges

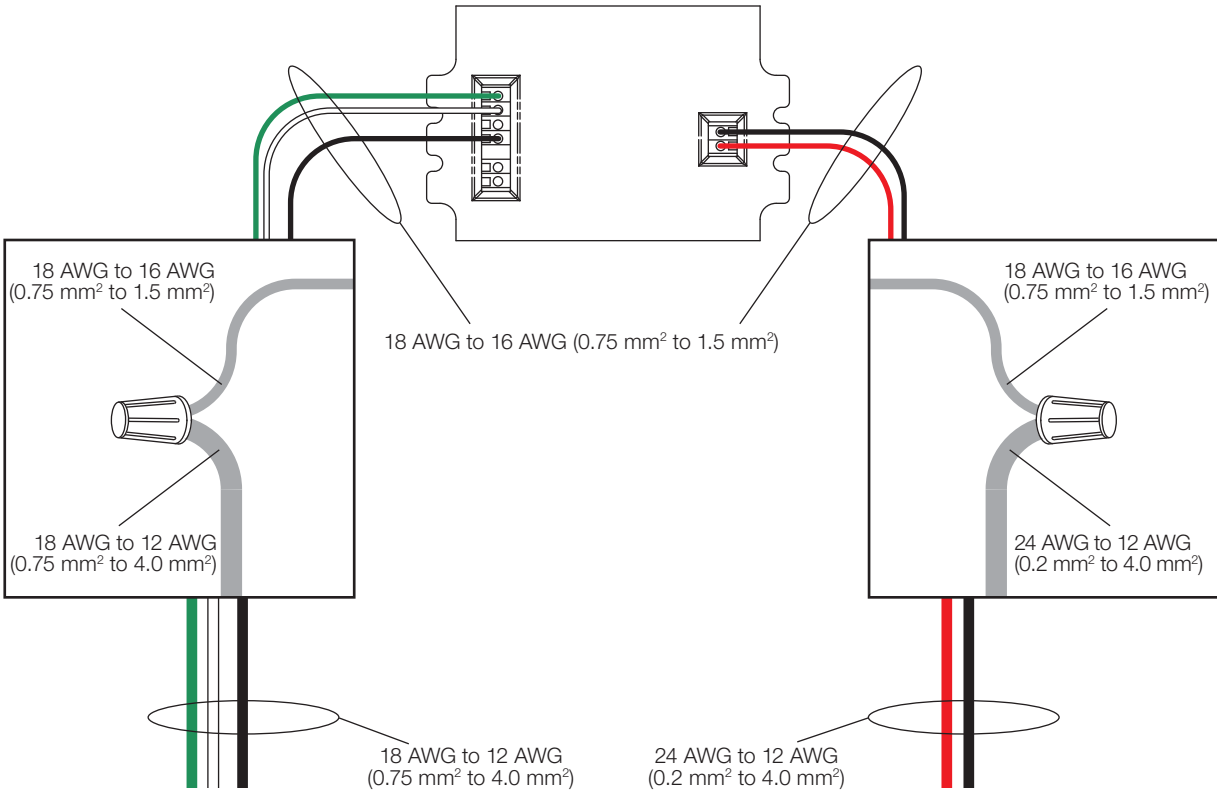

### Wiring Diagram for 2-Wire Control

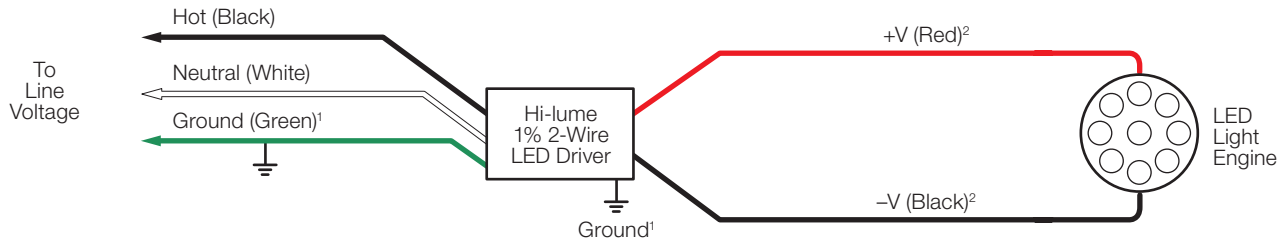

<sup>1</sup> Fixture and driver case must be grounded in accordance with local and national electrical codes; ground connection to driver case can be accomplished through ground terminal, and/or grounding the case.

<sup>2</sup> For maximum driver-to-LED light engine wire length, see charts in the **Driver Wiring and Mounting** section.

**Note:** Colors shown correspond to terminal blocks on driver.

Job Name:	Model Numbers:
Job Number:	

## Electricians and Contractors

### Driver Leads

Maximum driver-to-LED light engine wire length for  
**Constant-Current Drivers:**

Wire Gauge*	Maximum Lead Length		
	200 mA to 700 mA	710 mA to 1.50 A	1.51 A to 2.10 A
24 AWG (0.2 mm <sup>2</sup> )	8 ft (2.5 m)	4 ft (1.2 m)	2.75 ft (0.8 m)
22 AWG (0.34 mm <sup>2</sup> )	13 ft (4 m)	6 ft (1.8 m)	4.5 ft (1.5 m)
20 AWG (0.5 mm <sup>2</sup> )	20 ft (6 m)	10 ft (3 m)	7 ft (2 m)
18 AWG (0.75 mm <sup>2</sup> )	30 ft (9 m)	15 ft (4.5 m)	10 ft (3 m)
16 AWG (1.5 mm <sup>2</sup> )	35 ft (10.5 m)	25 ft (7.5 m)	15 ft (4.5 m)
14 AWG (2.5 mm <sup>2</sup> )	50 ft (15 m)	40 ft (12 m)	25 ft (7.5 m)
12 AWG (4.0 mm <sup>2</sup> )	100 ft (30 m)	60 ft (18 m)	40 ft (12 m)

Maximum driver-to-LED light engine wire length for  
**Constant-Voltage Drivers:**

Wire Gauge*	Maximum Lead Length		
	10 V to 20 V	20.5 V to 40 V	40.5 V to 60 V
24 AWG (0.2 mm <sup>2</sup> )	2.5 ft (0.8 m)	4 ft (1.2 m)	8 ft (2.5 m)
22 AWG (0.34 mm <sup>2</sup> )	4 ft (1.2 m)	6 ft (1.8 m)	12 ft (3.7 m)
20 AWG (0.5 mm <sup>2</sup> )	6 ft (1.8 m)	10 ft (3 m)	20 ft (6 m)
18 AWG (0.75 mm <sup>2</sup> )	10 ft (3 m)	15 ft (4.5 m)	30 ft (9 m)
16 AWG (1.5 mm <sup>2</sup> )	15 ft (4.5 m)	25 ft (7.5 m)	50 ft (15 m)
14 AWG (2.5 mm <sup>2</sup> )	25 ft (7.5 m)	40 ft (12 m)	75 ft (22.5 m)
12 AWG (4.0 mm <sup>2</sup> )	40 ft (12 m)	60 ft (18 m)	100 ft (30 m)

\* Terminal blocks on the drivers accept only solid 18 AWG or 16 AWG (0.75 mm<sup>2</sup> or 1.5 mm<sup>2</sup>) wire. To use wire gauges larger or smaller than this terminal blocks' rated gauge of 18 AWG or 16 AWG (0.75 mm<sup>2</sup> or 1.5 mm<sup>2</sup>) refer to the **Terminal Wiring Gauges** diagram on the previous page. Connect up to 3 ft (0.9 m) of 18 AWG or 16 AWG (0.75 mm<sup>2</sup> or 1.5 mm<sup>2</sup>) wire to the LED driver terminal blocks, then connect 14 AWG to 12 AWG (2.5 to 4.0 mm<sup>2</sup>) or 24 AWG to 20 AWG (0.20 mm<sup>2</sup> to 0.50 mm<sup>2</sup>) up to the length allowed in the above table.

### Wiring and Grounding

Driver and lighting fixture must be grounded. Drivers must be installed per national and local electrical codes.

### LED Load Replacement

For Class 2 rated drivers, the LED load can be changed while the driver is installed and powered.

### Maximum Driver Operating Temperature

Driver case temperature ( $t_c$ ) must not exceed UL conditions of acceptability in end product.

For 50,000 hour lifetime, driver case temperature ( $t_c$ ) must not exceed 65 °C.

Lutron,  Lutron, Hi-lume, C•L, Caseta, GRAFIK Eye, PowPak, Quantum, Nova T<sup>+</sup>, Nova, Skylark, Diva, Ariadni, Maestro, Maestro Wireless, RadioRA, and HomeWorks are trademarks of Lutron Electronics Co., Inc., registered in the U.S. and other countries. Energi Savr Node, QwikFig, GRAFIK, GRAFIK Systems, GRAFIK T, myRoom, and RadioRA 2 are trademarks of Lutron Electronics Co., Inc.

## LUTRON SPECIFICATION SUBMITTAL

Page

<b>Job Name:</b>	<b>Model Numbers:</b>
<b>Job Number:</b>	

## Facilities Managers

### SERVICE

#### Warranty

For warranty information, please visit [www.lutron.com/driverwarranty](http://www.lutron.com/driverwarranty)

#### Replacement Parts

When ordering Lutron replacement parts please provide the full model number. Consult Lutron Customer Assistance at 1.844.LUTRON1 if you have any questions.

#### Further Information

For further information, please visit us at [www.lutron.com/hilume1led](http://www.lutron.com/hilume1led) or contact our LED Control Center of Excellence at 1.877.346.5338 or [LEDs@lutron.com](mailto:LEDs@lutron.com)

#### EMC Information

This device complies with part 15 of the FCC Rules. Operation is subject to the following two conditions: (1) This device may not cause interference, and (2) this device must accept any interference, including interference that may cause undesired operation.

#### FOR UL RECOGNIZED MODELS ONLY:

**NOTE:** This equipment has been tested and found to comply with the limits for a Class A digital device, pursuant to part 15 of the FCC rules. These limits are designed to provide reasonable protection against harmful interference when the equipment is operated in a commercial environment. This equipment generates, uses and can radiate radio frequency energy and, if not installed and used in accordance with the instruction manual, may cause harmful interference to radio communications. Operation of this equipment in a residential area is likely to cause harmful interference in which case the user will be required to correct the interference at his own expense.

#### FOR UL LISTED MODELS ONLY:

**NOTE:** This equipment has been tested and found to comply with the limits for a Class B digital device, pursuant to part 15 of the FCC Rules. These limits are designed to provide reasonable protection against harmful interference in a residential installation. This equipment generates, uses and can radiate radio frequency energy and, if not installed and used in accordance with the instructions, may cause harmful interference to radio communications. However, there is no guarantee that interference will not occur in a particular installation. If this equipment does cause harmful interference to radio or television reception, which can be determined by turning the equipment off and on, the user is encouraged to try to correct the interference by one or more of the following measures:

- Reorient or relocate the receiving antenna.
- Increase the separation between the equipment and receiver.
- Connect the equipment into an outlet on a circuit different from that to which the receiver is connected.
- Consult the dealer or an experienced radio/TV technician for help.

<b>Job Name:</b>	<b>Model Numbers:</b>
<b>Job Number:</b>	